



# CNG SYSTEM INSTALLATION INSTRUCTIONS

**2021 - 2022 FORD TRANSIT 3.5L PFDI - CARGO  
BI-FUEL NATURAL GAS SYSTEM**

*Updated: 7-15-2021*



---

## TABLE OF CONTENTS

	<b>PAGES</b>
<b>PREFACE - WARNINGS, CAUTIONS &amp; DISCLAIMERS.....</b>	<b>2</b>
<b>DISCONNECT THE BATTERY.....</b>	<b>3</b>
<b>CNG TANK INSTALLATION (FRONT TO BACK - DRIVER SIDE).....</b>	<b>4-17</b>
<b>CNG TANK INSTALLATION (LEFT TO RIGHT BEHIND FRONT SEATS).....</b>	<b>18-25</b>
<b>BI-FUEL WIRE HARNESS DIAGRAM.....</b>	<b>26</b>
<b>CAN BUS PIGTAIL WIRE HARNESS INSTALLATION.....</b>	<b>27-28</b>
<b>MAIN WIRE HARNESS INSTALLATION.....</b>	<b>29-30</b>
<b>REAR WIRE &amp; SOLENOID WIRE HARNESS INSTALLATION.....</b>	<b>31</b>
<b>FUEL GAUGE WIRE HARNESS INSTALLATION.....</b>	<b>32-34</b>
<b>UNDERHOOD FUEL DELIVERY INSTALLATION.....</b>	<b>35-38</b>
<b>FUEL FILL INSTALLATION.....</b>	<b>39-43</b>
<b>REGULATOR / FILTER / QUARTER TURN SHUT-OFF ASSEMBLY INSTALLATION.....</b>	<b>44</b>
<b>ROUTING THE LOW PRESSURE NATURAL GAS FUEL HOSE.....</b>	<b>45</b>
<b>INSTALLATION OF COOLANT HOSES.....</b>	<b>46-47</b>
<b>CYLINDER COVER INSTALLATION (FRONT TO BACK - DRIVER SIDE).....</b>	<b>48</b>
<b>CYLINDER COVER INSTALLATION (LEFT TO RIGHT - BEHIND FRONT SEATS).....</b>	<b>49</b>
<b>DECAL / STICKER PLACEMENT LOCATIONS.....</b>	<b>50-51</b>
<b>LEAK &amp; FINAL SYSTEM INSTALLATION QUALITY CONTROL INSPECTION.....</b>	<b>52</b>

---

## PREFACE - WARNINGS, CAUTIONS & DISCLAIMERS

The installer, operator, company, firm, or organization assumes all responsibility for the proper installation of the system and assuring that the system is properly installed, maintained and operating in a safe condition on the vehicle when installed. Altech-Eco disclaims liability for, or responsibility for: (a) any damages, injury, disability or death that can occur from installation errors or lack of maintenance or training; or (b) any consequential or special damages, including, but not limited to damages from lost profits or similar claims.

To the fullest extent permitted by law, the installer, operator, company, firm, or organization shall indemnify, defend and hold harmless Altech-Eco, its directors, officers, employees and agents from and against all claims, demands, suits, judgments, actions and liability arising out of personal or bodily injury or death of any person (including Installer's employees) or damage to or destruction of any property (including economic loss) sustained by any person or entity as a result of installation of the system on any vehicle regardless of when such injury or damage is detected or when such death occurs, unless such injury, death, damage or loss was directly caused by the sole negligence of Altech, its officers, employees or agents.

This installation guide contains information and instructions required for the installation of the Altech-Eco natural gas systems. It does not explain everything you need to know about working with compressed natural gas equipment, fuel tanks, valves, fuel lines, and other pressurized components.

The system must only be installed and serviced by trained and certified technicians. Individual operator training is the responsibility of the company, firm, or organization placing the system in service. Reading this installation guide does not constitute certification.

This installation guide contains Cautions and Notices that must be observed at all times to reduce the risk of personal injury during operation and installation. Improper installations procedures may damage the system or make the system unsafe to operate. These Cautions and Notices are not all inclusive. Altech-Eco cannot possible warn of all potentially hazardous consequences caused by failure to follow these instructions and not having proper training and understanding of natural gas high pressure systems.

Be aware that this installation requires the use of high pressure, flammable, and highly explosive compressed natural gas. CNG is stored at 3,600 psi and at 70°F (21°C).

This installation is intended for unmodified vehicles. If the vehicle has been modified, consult Altech-Eco before beginning the installation.

This document contains proprietary data of Altech-Eco and shall not be used or disclosed in whole or in part to design or fabricate any product for any purpose, nor reproduced or transmitted to any other organization without the express permission of Altech-Eco.

This installation guide is subject to change at any time without notice. All updated versions are available on Altech-Eco installer portal. Contact Altech-Eco if you are unsure of the latest version.

---

## DISCONNECT THE BATTERY

1. Make sure vehicle key is not in the ignition and that all electrical components are OFF before starting the battery disconnection process .
2. The battery is located under the driver seat. Some vehicles have two batteries. See OEM manual for information.
3. Follow OEM instructions to remove covers to access the battery(s).
4. Disconnect the negative terminal on the battery and place a plastic cap on the terminal to protect from accidental contact. If the vehicle has two batteries, then disconnect both negative terminals.

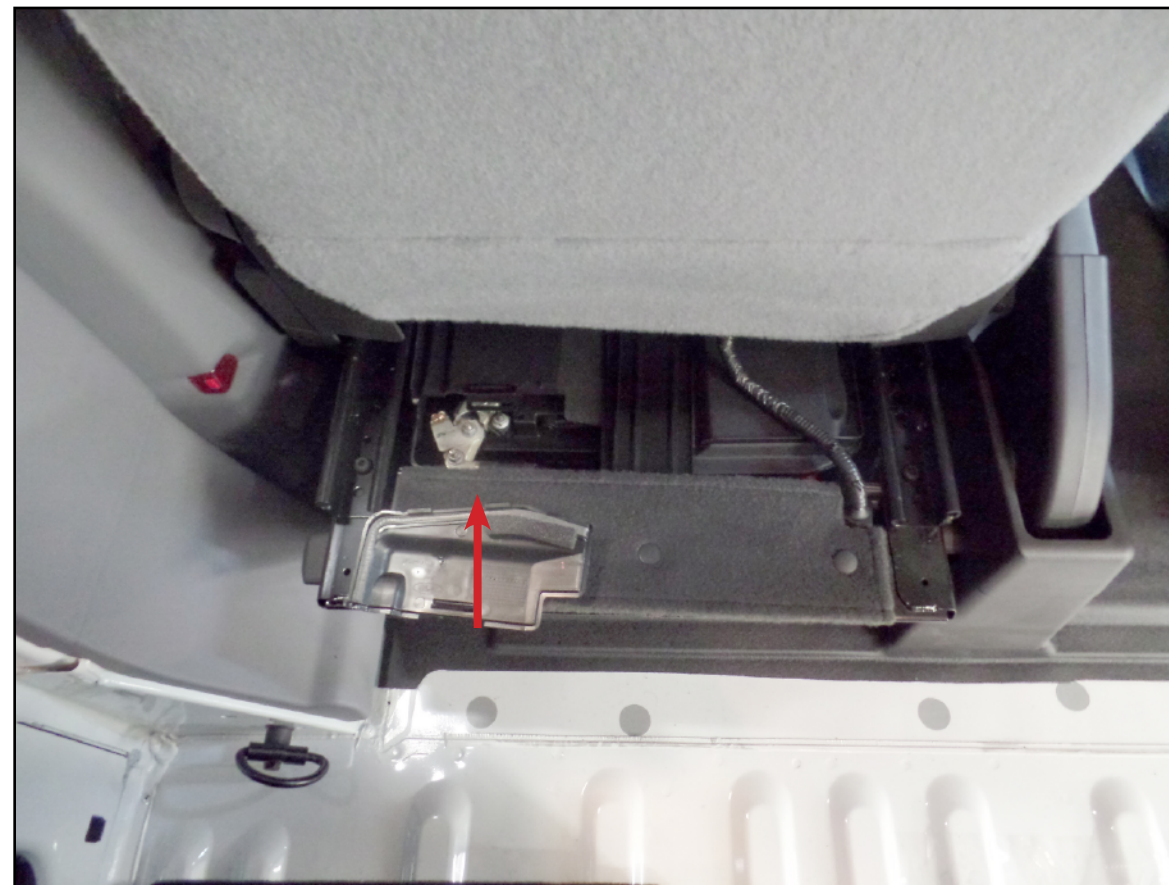

## CNG TANK INSTALLATION (FRONT TO BACK - DRIVER SIDE)

- 21 GGE (Qty 1) 21" x 60" Type 4 CNG Tank.  
Must have 148" Wheelbase, 130" will not fit this size tank.

### Note:

Placement of tank may change depending on other items that need installed (ex. partition, shelving, etc.). Check with customer prior to installation of CNG tank. Contact system provider for assistance as needed. The tank must be secured properly to the body.

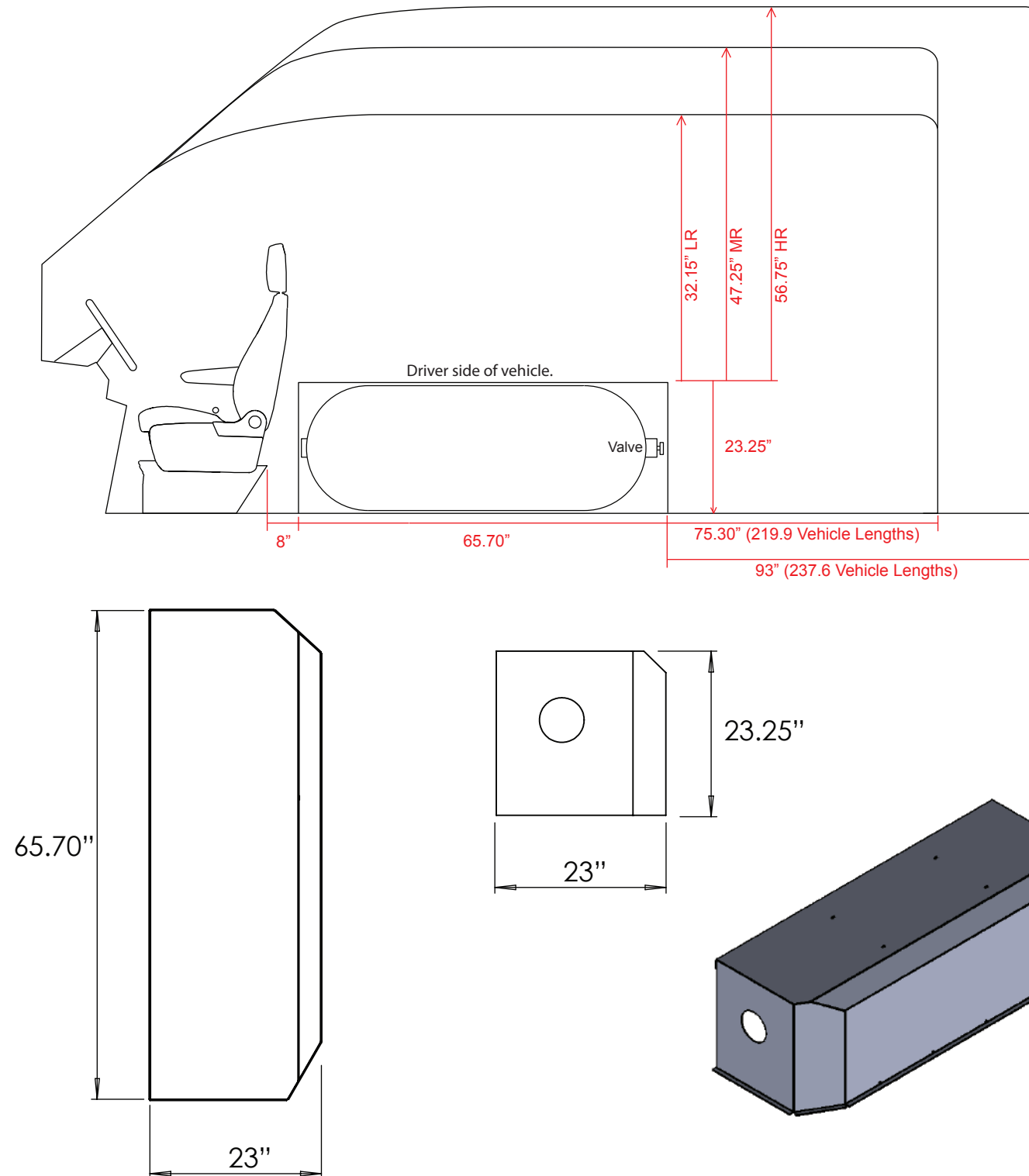

## CNG TANK INSTALLATION (FRONT TO BACK - DRIVER SIDE)

1. Remove anchor hooks.
2. Use cylinder plate as a template.

**Note:** Combining tank brackets with plate may be done on next page, step 6.  
Line it up with the anchor points towards the back.  
Secure plate with OEM anchor bolts towards the wall.

**If the vehicle does not have a floor mat, proceed to step 6.**

3. Trace around the cylinder plate.
4. Remove cylinder plate.
5. Cut out the traced part on the floor mat.

### Note:

Placement of tank may change depending on other items that need installed (ex. partition, shelving, etc..). Check with customer prior to installation of CNG tank. Contact system provider for assistance as needed. The tank must be secured properly to the body.

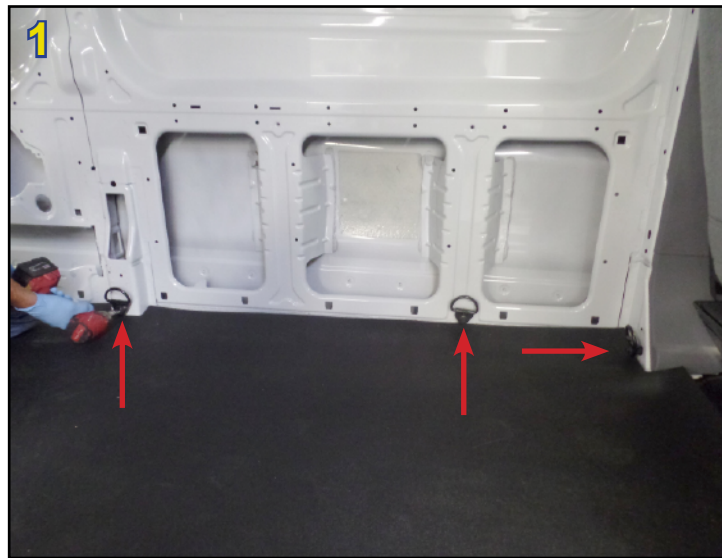

## CNG TANK INSTALLATION (FRONT TO BACK - DRIVER SIDE)

6. Place cylinder plate back into location.  
Secure with 2 OEM anchor bolts.
7. Mark nine drill point locations.  
Be aware that one will need a stopper due to fuel tank below.
8. NOTE: Always drill pilot holes first to verify measurements.  
Drill the points. Deburr. Rust proof.

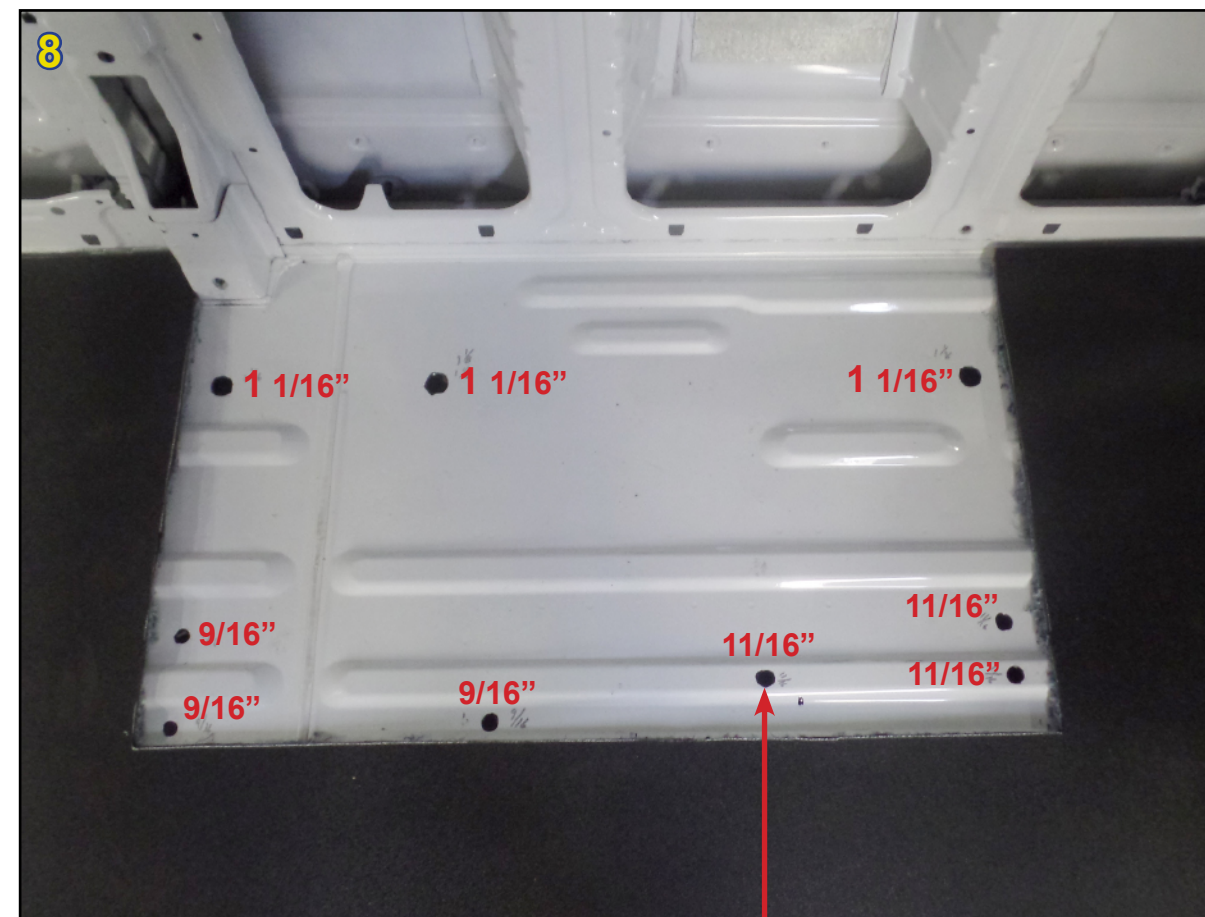
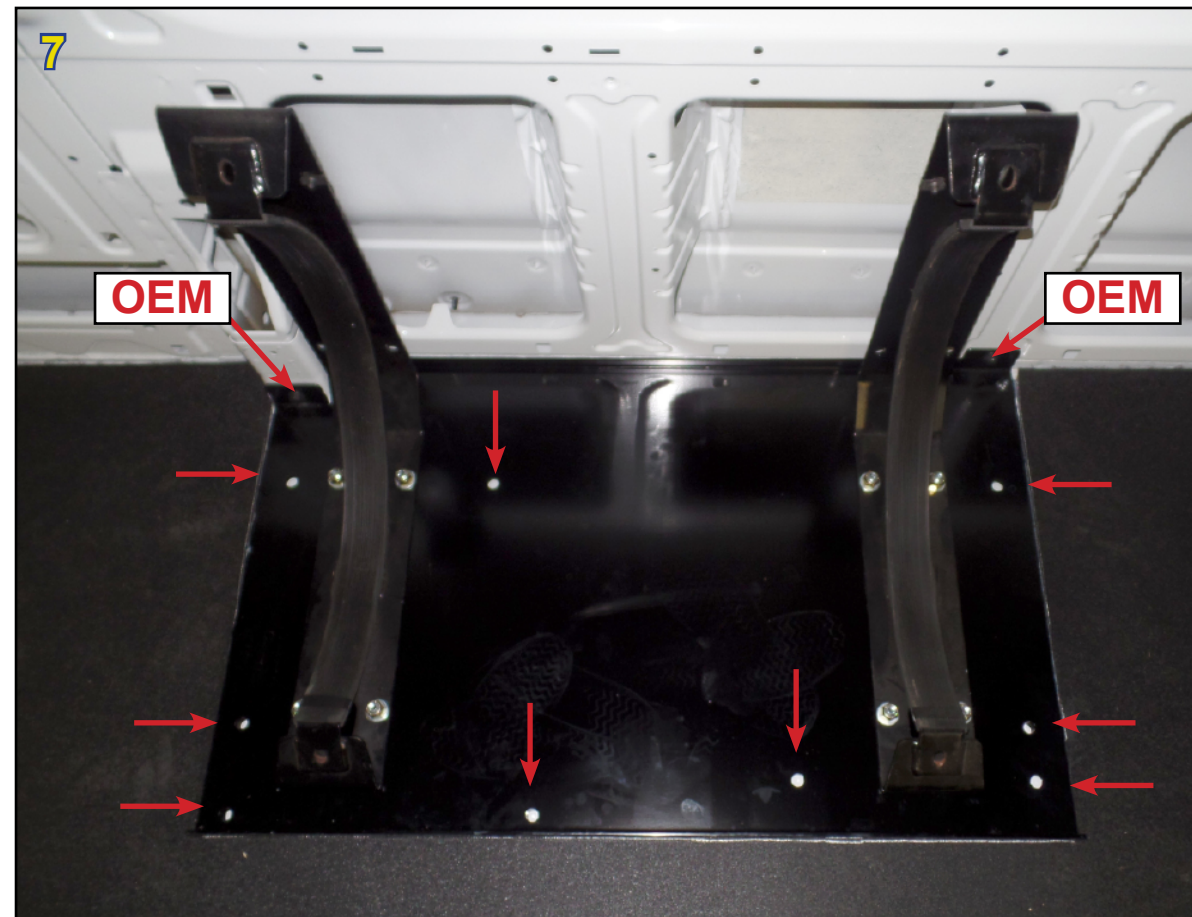

CAUTION: Use a stopper. DO NOT drill deeper than 1". Fuel tank below.

## CNG TANK INSTALLATION (FRONT TO BACK - DRIVER SIDE)

**Note: Hand start ALL bolts for all locations before tightening.**

9. Place three spacers into 1 1/16" holes.
10. Install three rivet nuts into 11/16" holes. Bottom right corner.
11. (If bottom cylinder brackets have not been installed previously. You may combine them now. Secure with eight 1 1/2-13 x 1 1/4" bolts (thread facing up), 1/2" nuts, and 1/2" flat washers.
12. Install cylinder plate.  
Secure with two OEM bolts against the wall.  
Secure with three 6 1/2" bolts into the spacers.  
Secure with three 2" bolts in bottom left of cylinder plate, 9/16" holes.  
Install six backing plates underneath (refer to next page for pictures).  
Secure with washer and nut.  
Secure with three 1 1/2" bolts into rivet nuts, bottom right corner.  
Tighten to 60-65 ft-lbs. Two OEM bolts to 45 ft-lbs.

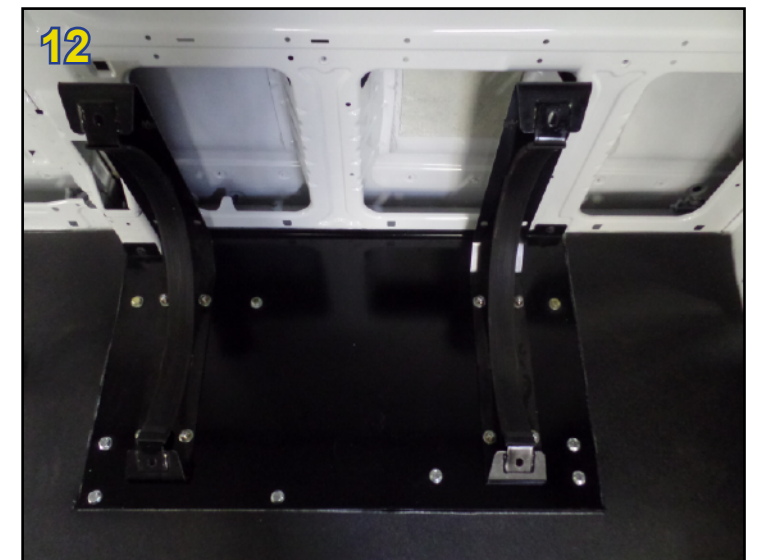
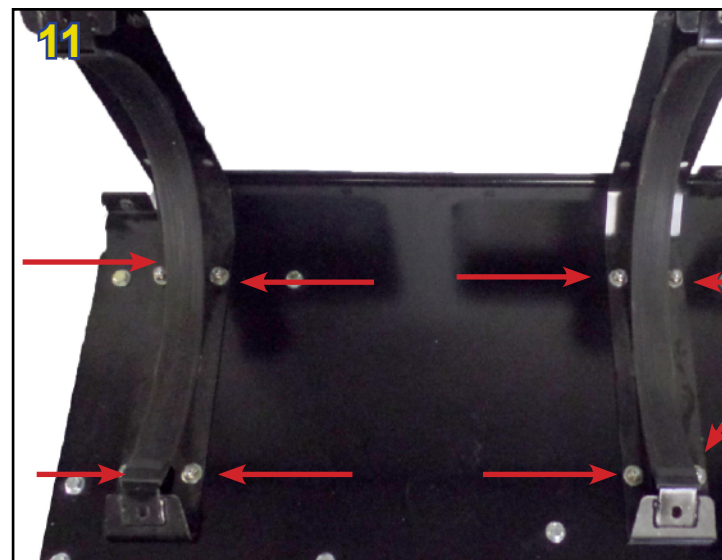
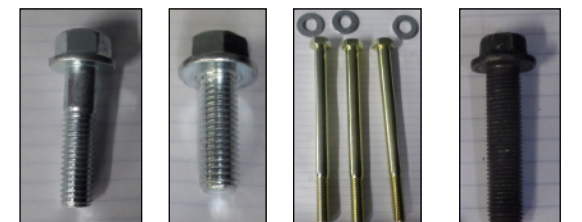



## CNG TANK INSTALLATION (FRONT TO BACK - DRIVER SIDE)

Additional pictures for step 12.

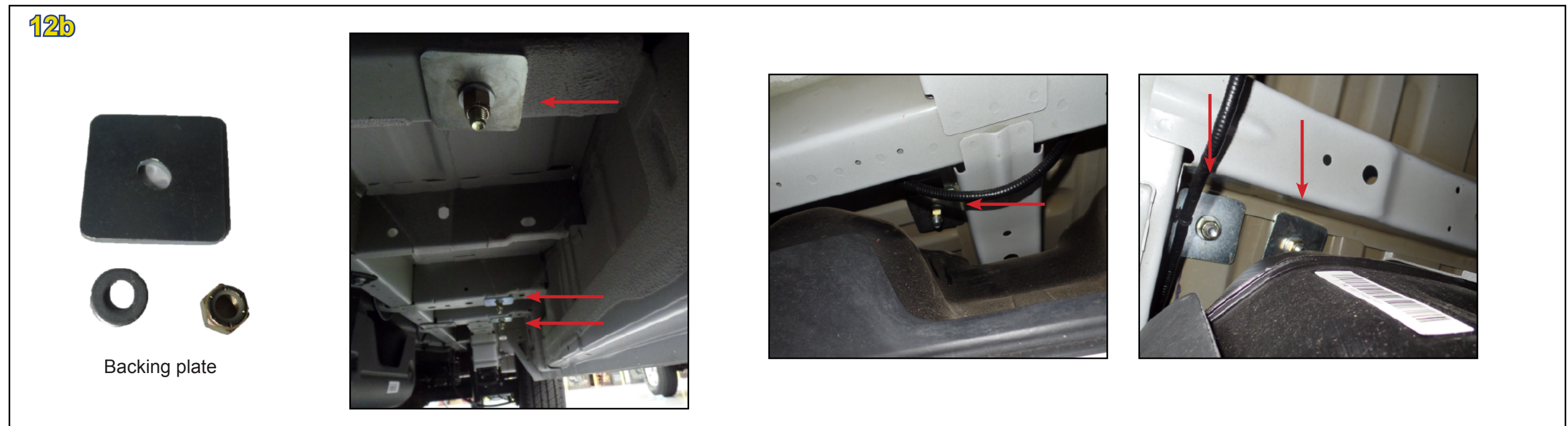

## CNG TANK INSTALLATION (FRONT TO BACK - DRIVER SIDE)

13. Measure out and drill specified size holes in areas shown.

NOTE:

- Always drill pilot holes first and confirm measurements.
- Measure from the edge of the cylinder plate.

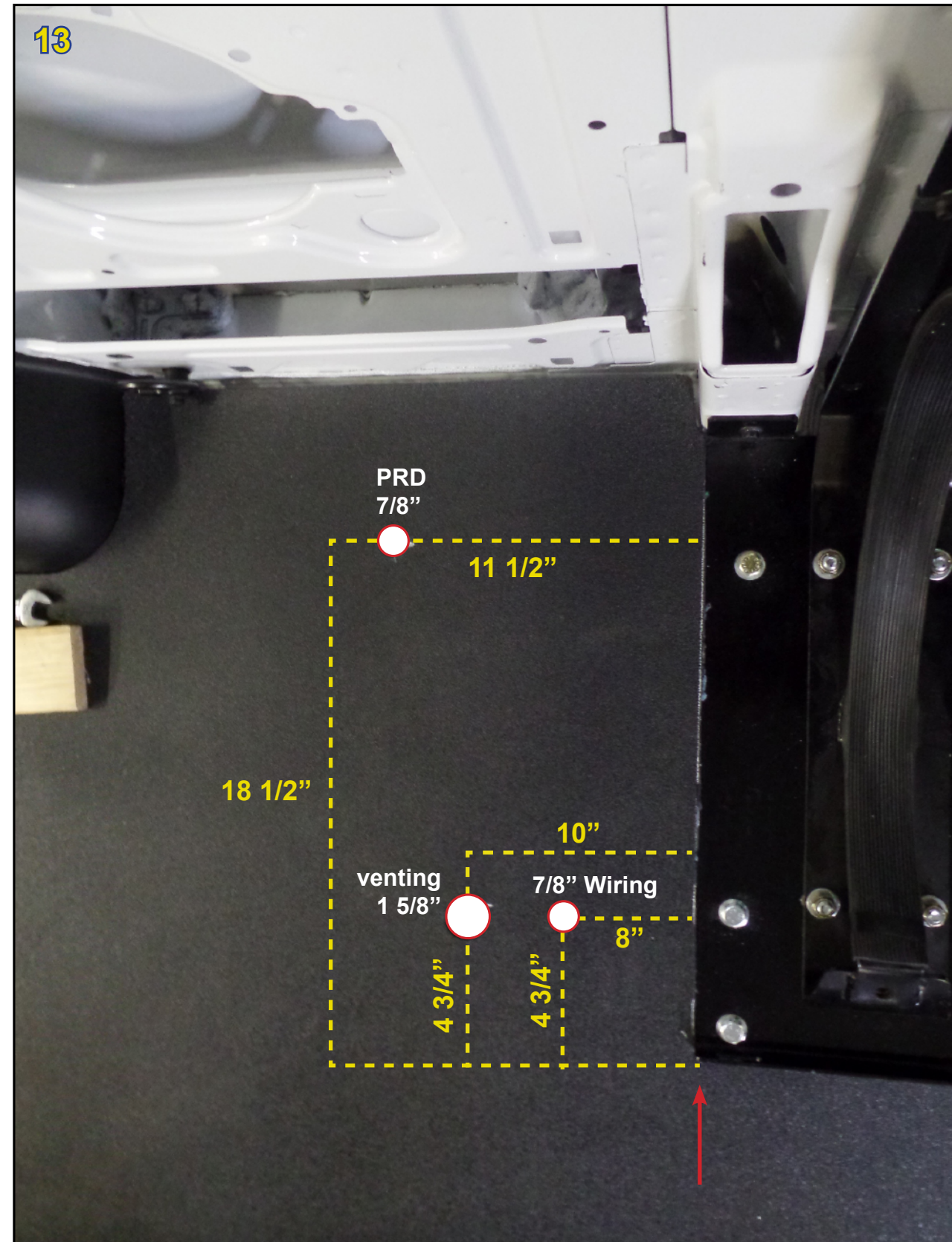

## CNG TANK INSTALLATION (FRONT TO BACK - DRIVER SIDE)

14. Install cylinder.  
Solenoid facing down.
15. Using a right angle, space the cylinder 9 1/4" from the edge of the cylinder plate.

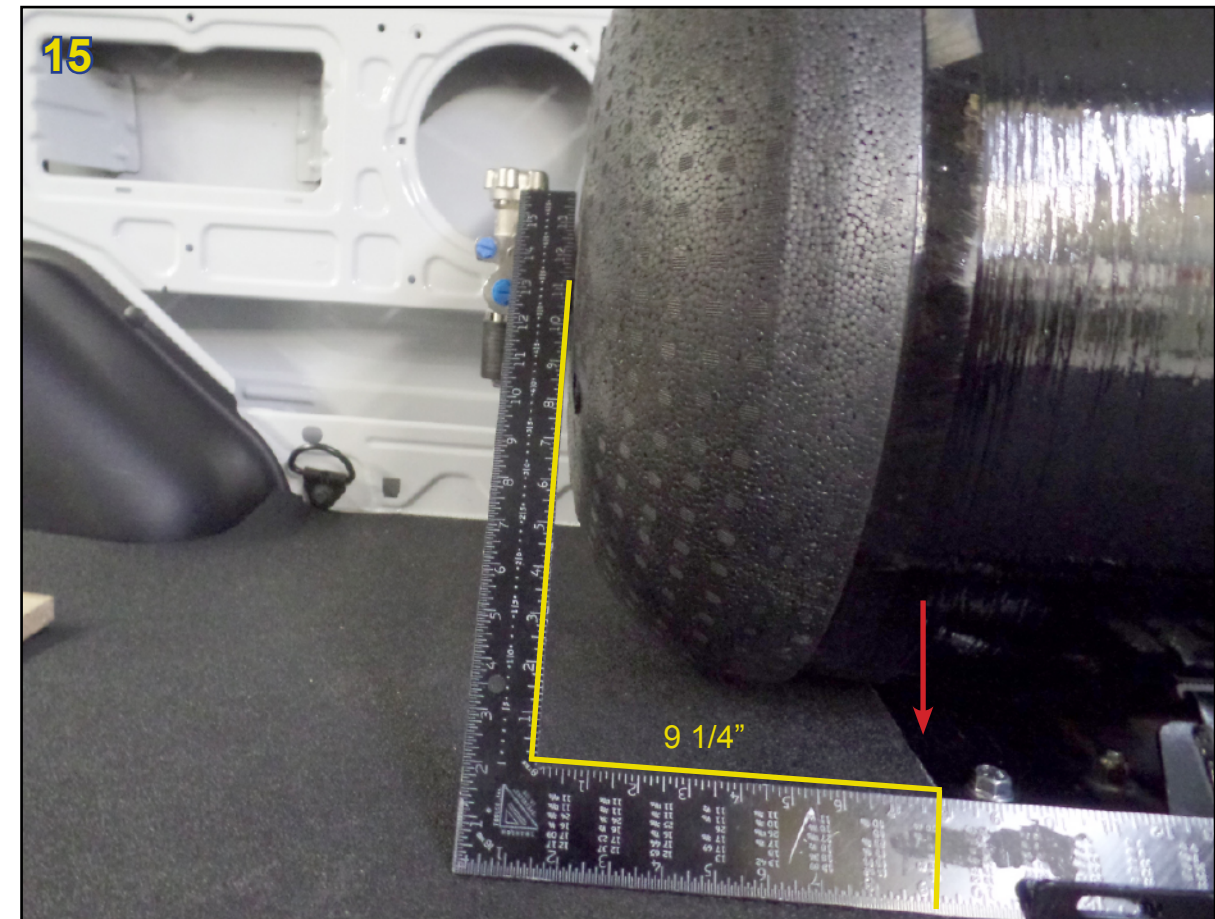

## CNG TANK INSTALLATION (FRONT TO BACK - DRIVER SIDE)

16. Install fittings.  
Two plugs. Two fittings. Leave the 45 degree fitting loose until high pressure hose is attached.  
Tighten all to 30-35 ft-lbs.  
Apply venting decal on tank above the valve and ensure it is clearly visible.
17. Install grommet.
18. Install PRD tube.  
To tighten, first hand tighten, then make a full turn plus additional 1/4 turn.

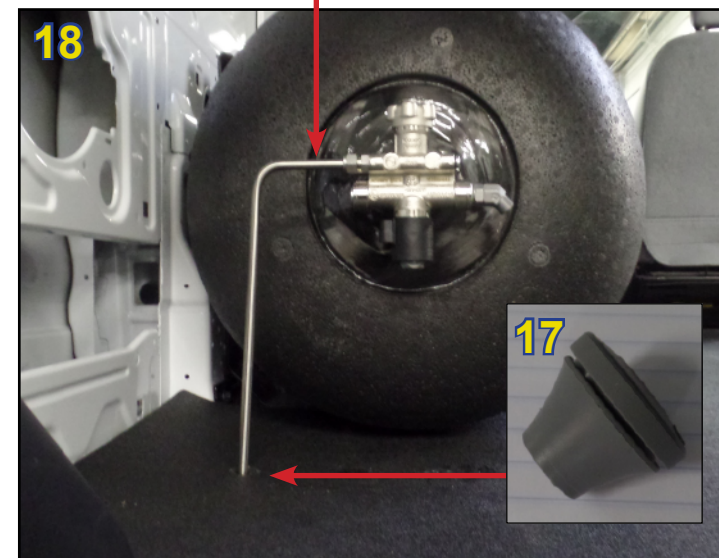
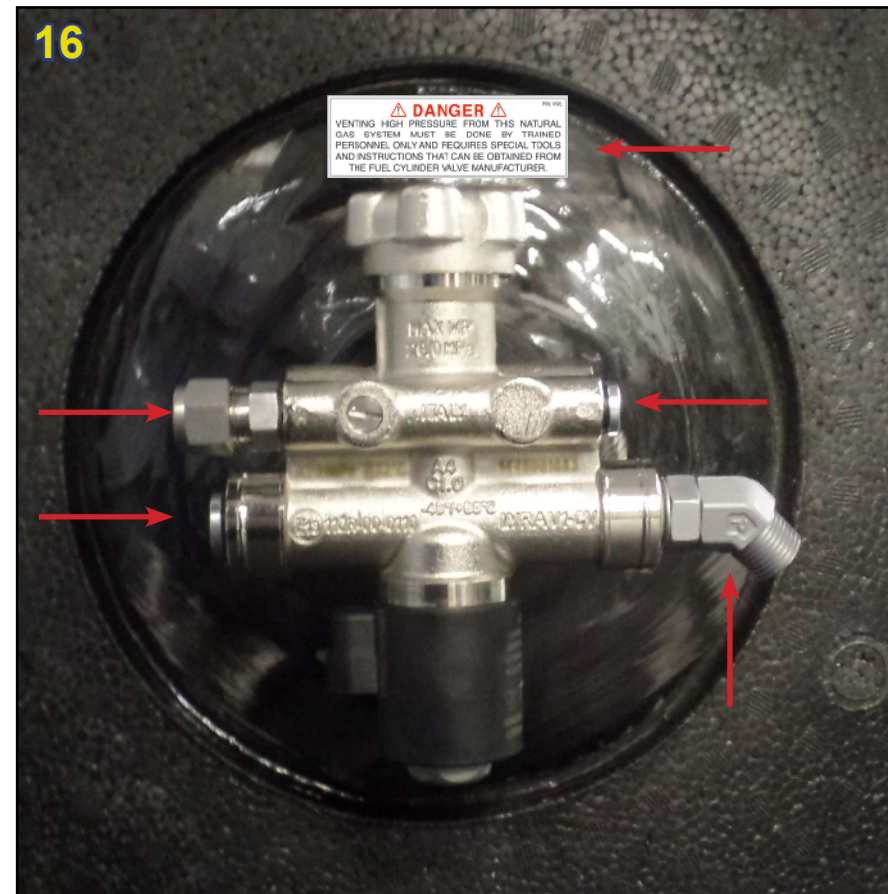

## CNG TANK INSTALLATION (FRONT TO BACK - DRIVER SIDE)

19. Install 1 3/4" grommet into the vehicle floor for the vent tube.
20. Run vent tube and 83" high pressure hose through the grommet.  
Tighten high pressure hose to 30-35 ft-lbs on each end when connected.  
Cover left plug with a vinyl cap and place hose clamp over it. Leave loose until after the leak test.

**NOTE:** (A) Do not tighten hose clamp on vent tube until a leak test has been performed.

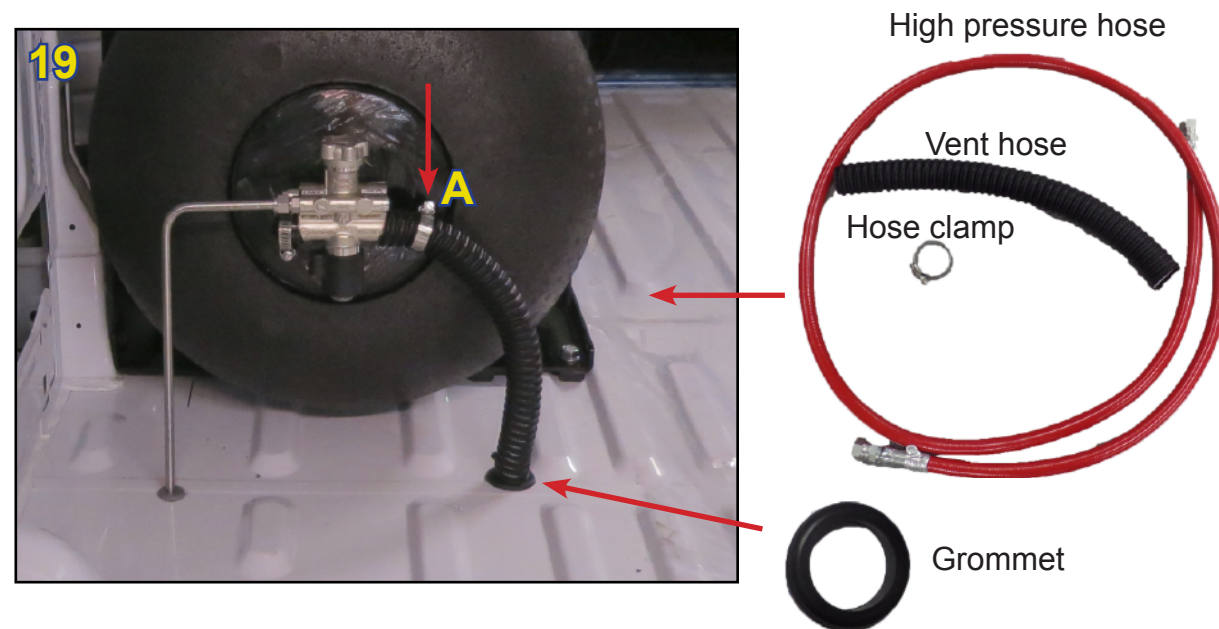

## CNG TANK INSTALLATION (FRONT TO BACK - DRIVER SIDE)

21. Install box top cylinder brackets onto cylinder. Make sure to level each one.
22. Use bracket bolts and secure both connect both parts of the cylinder brackets and tighten to 45 ft-lbs.  
Thread must be facing up.

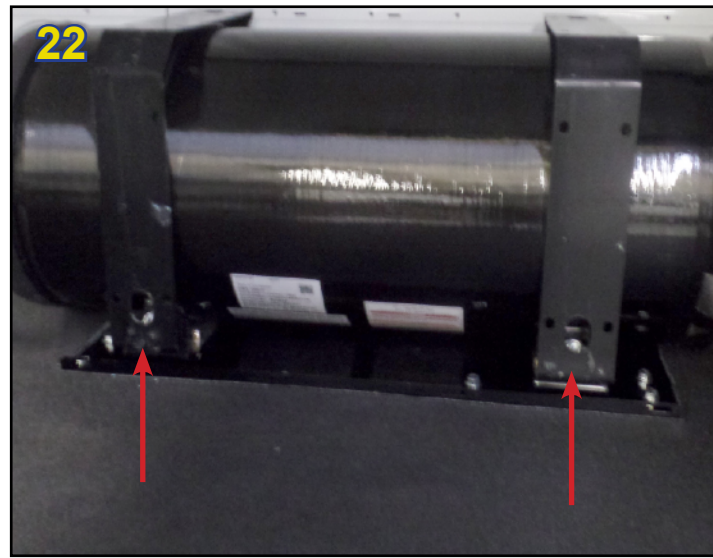

## CNG TANK INSTALLATION (FRONT TO BACK - DRIVER SIDE)

23. Secure high pressure hose with poly nuts and p-clamps underneath the vehicle in locations shown.  
Place a high pressure decal onto the hose.

**Note:** Deburr and rust proof each drill point.



USE OEM hole, install poly nut.

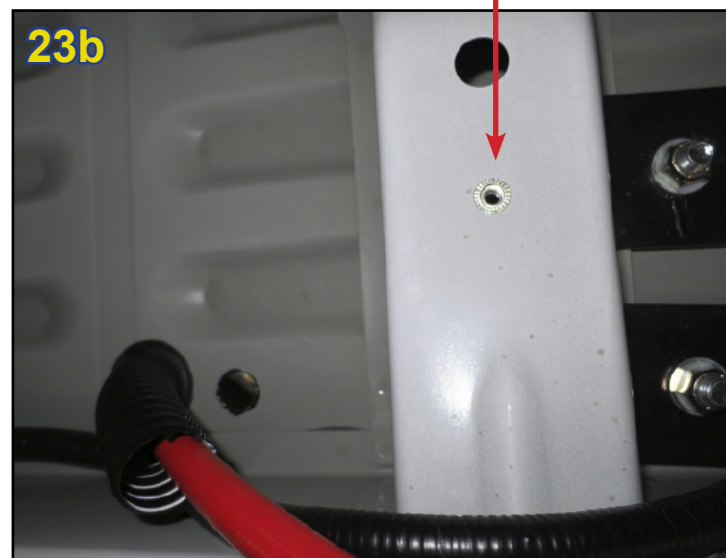

P-clamps, bolts, and poly nuts.



Open this to 25/64" hole. Install poly nut.



Measure 1/2" from location shown. Drill a hole to 25/64". Install poly nut.

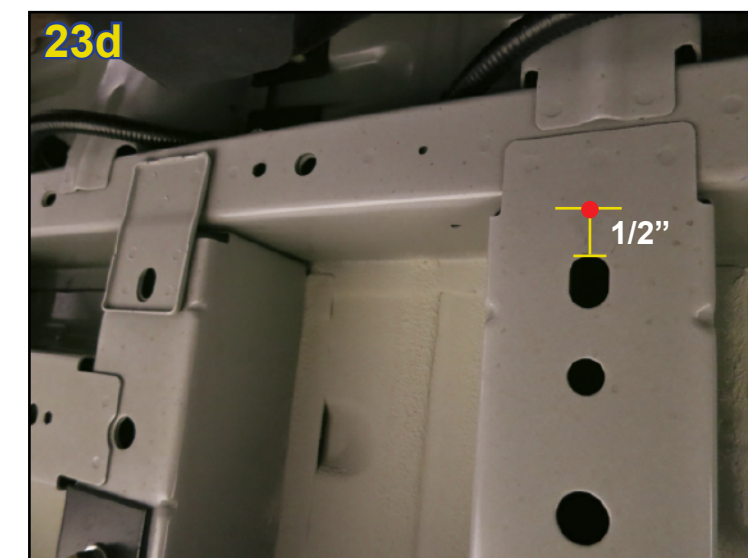

## CNG TANK INSTALLATION (FRONT TO BACK - DRIVER SIDE)

- 23. Continued...
- 24. Cap the PRD tube.



Drill this to 25/64" hole. Install poly nut.

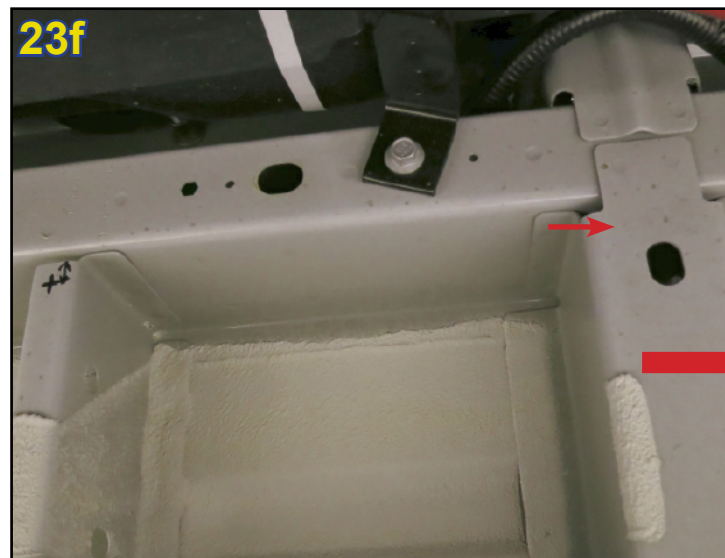
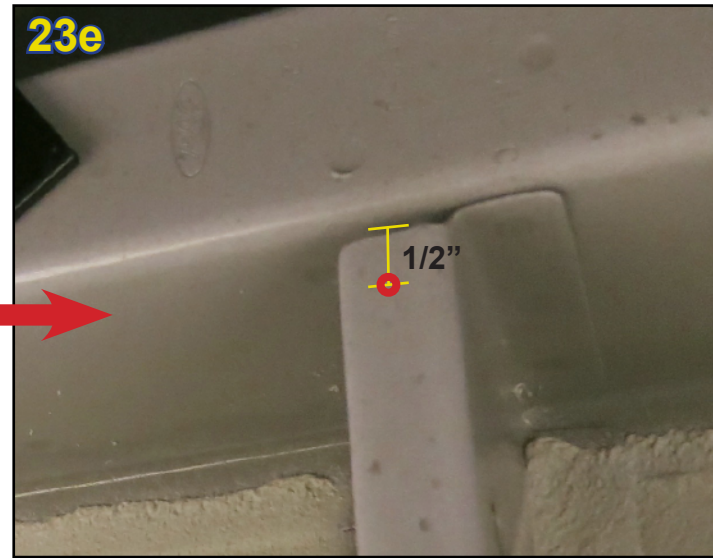

Drill this to 25/64" hole. Install poly nut.

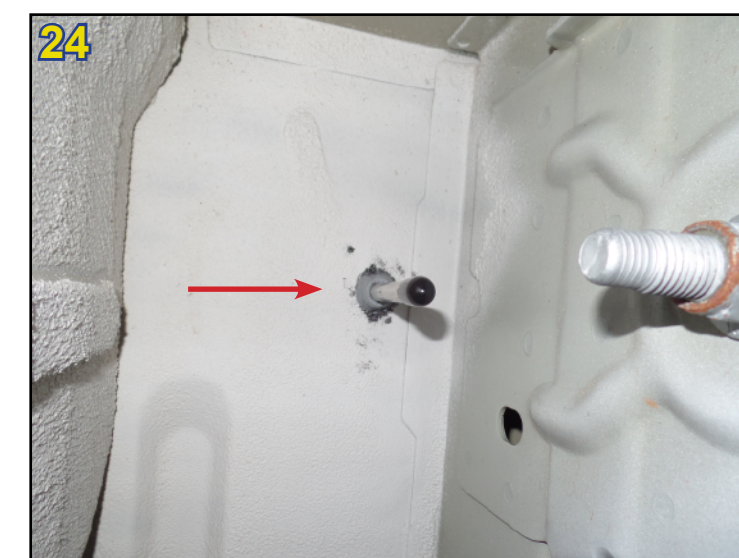
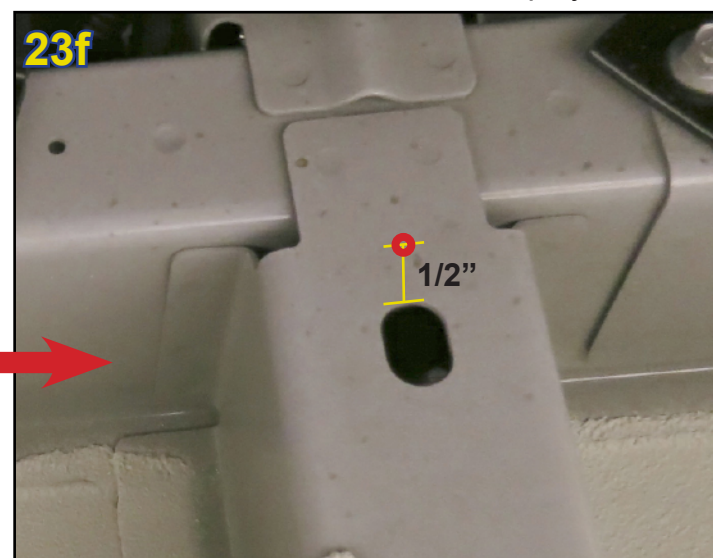



## CNG TANK INSTALLATION (FRONT TO BACK - DRIVER SIDE)

### ADDITIONAL PICTURES

Avoid sharp edges and corners when routing the high pressure hoses. Improper routing will cause the hose to fail from friction or rubbing.

Connect high pressure hose to the cross assembly. Tighten to 30-35 ft-lbs.



## CNG TANK INSTALLATION (FRONT TO BACK - DRIVER SIDE)

25. Apply cylinder cover decal on tank bracket in location that is easily viewed.

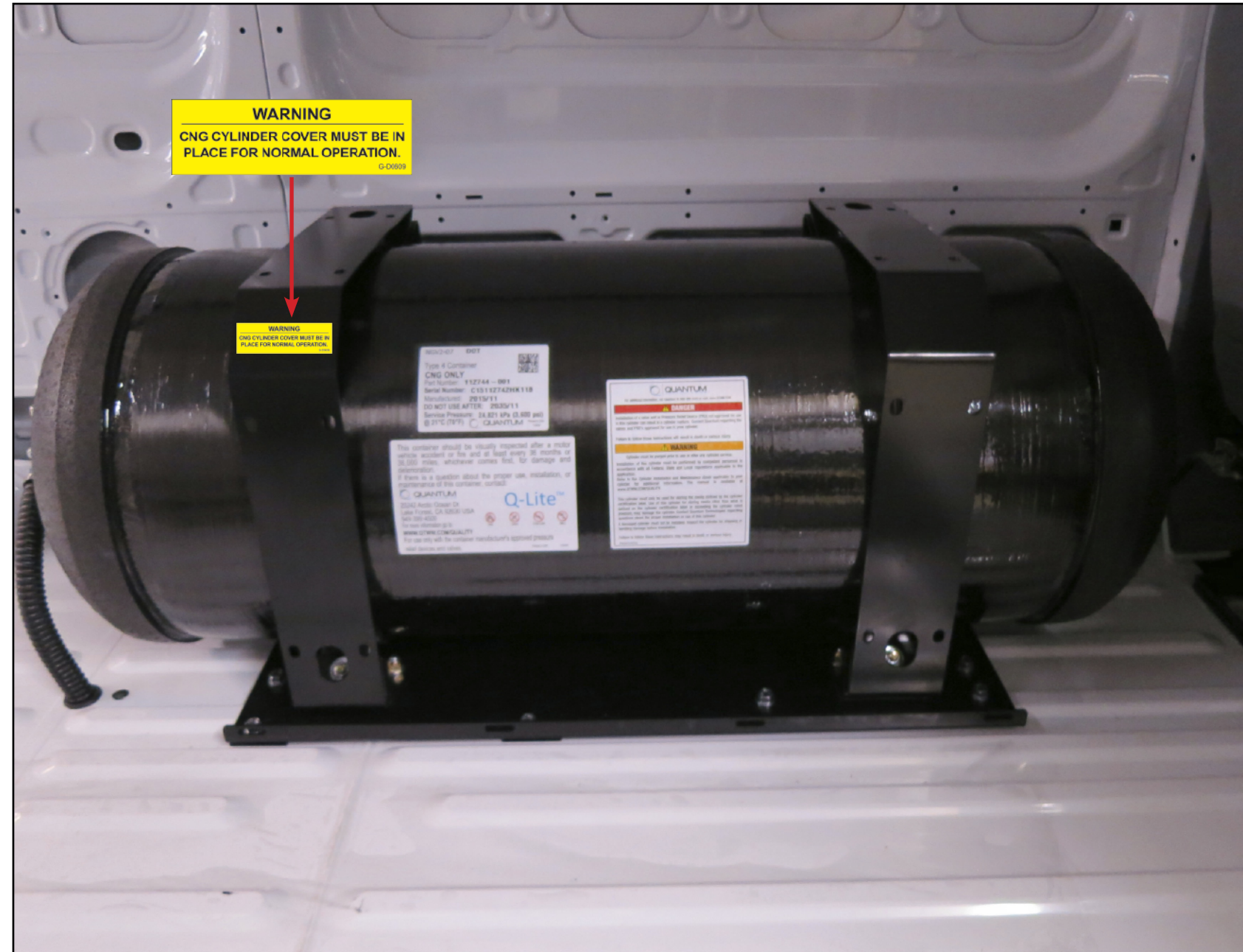

# CNG TANK INSTALLATION (LEFT TO RIGHT BEHIND FRONT SEATS)

• 21 GGE (Qty 1) 21" x 60" Type 4 CNG Tank.

**Note:**

Placement of tank may change depending on other items that need installed (ex. partition, shelving, etc..). Check with customer prior to installation of CNG tank. Contact system provider for assistance as needed. The tank must be secured properly to the body.

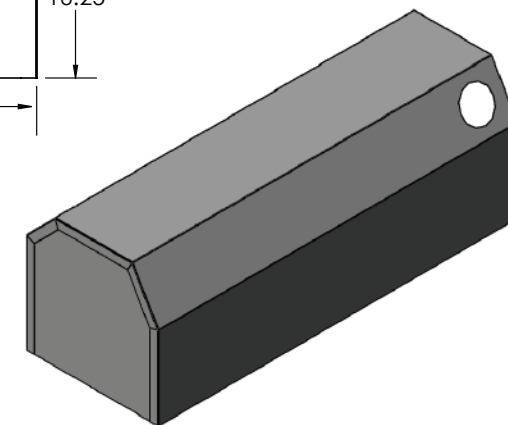
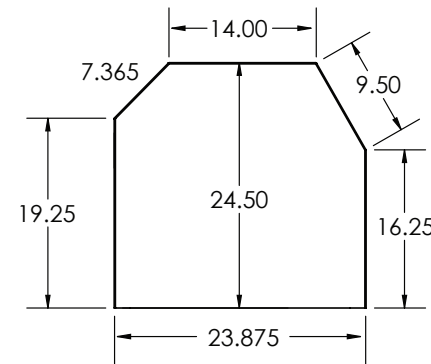
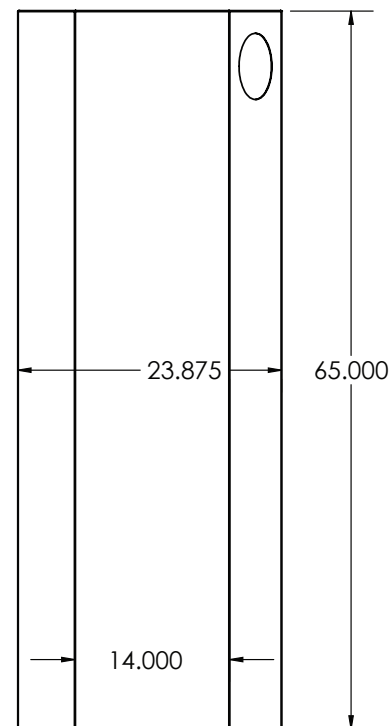
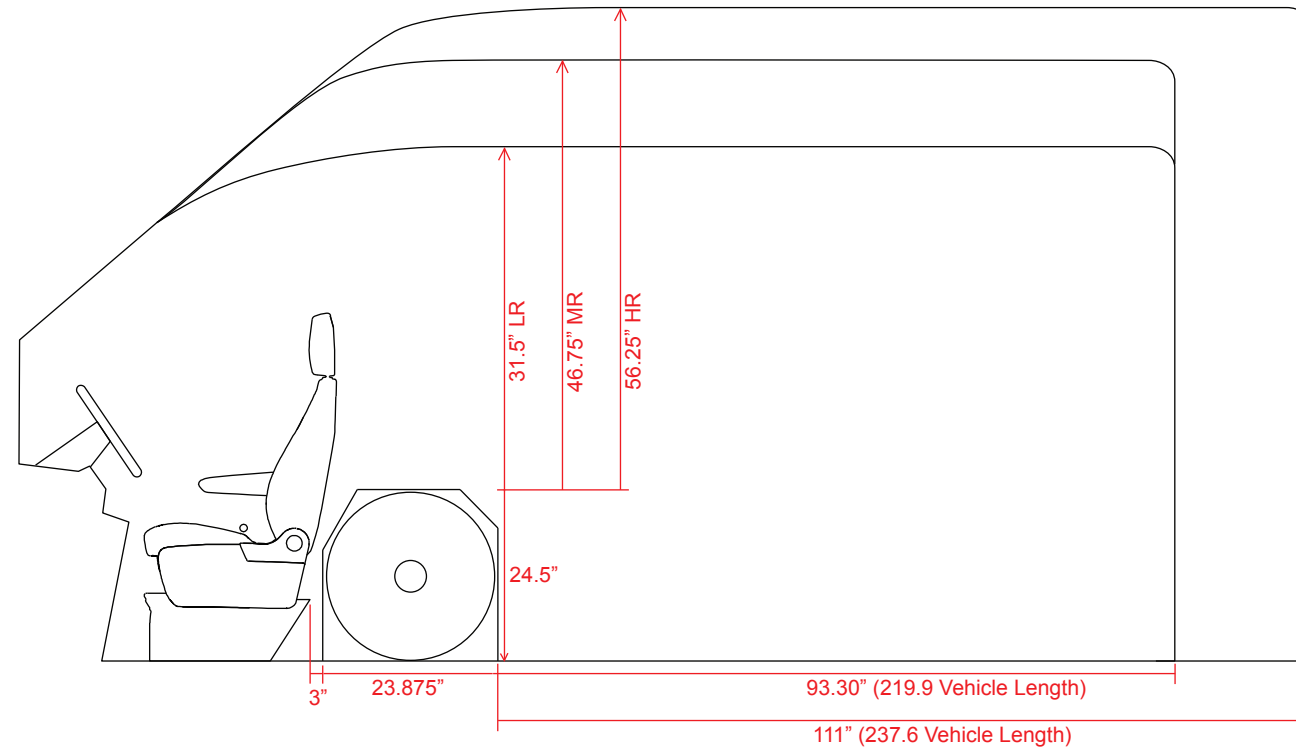

## CNG TANK INSTALLATION (LEFT TO RIGHT BEHIND FRONT SEATS)

1. Remove anchor hooks.  
Passenger side - Discard the one located behind passenger seat. Save the hook located at step panel for reuse.  
Driver side - Discard both hooks.
2. Remove step panel. Four bolts.
3. Modify lining by cutting off 27 7/8" piece. Discard that piece.

### Note:

Placement of tank may change depending on other items that need installed (ex. partition, shelving, etc..). Check with customer prior to installation of CNG tank. Contact system provider for assistance as needed. The tank must be secured properly to the body.

**NOTE:** Some vehicles will NOT have a floor mat. If that is so, move past the steps involving the floor mat.

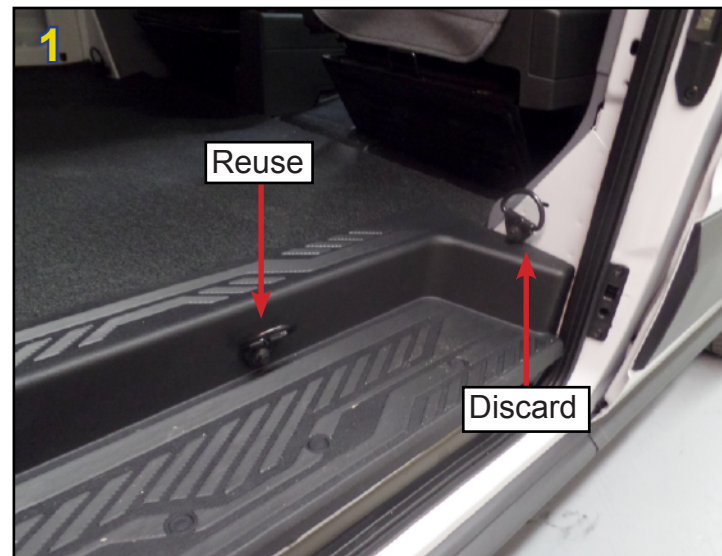

Cut off 27 7/8"

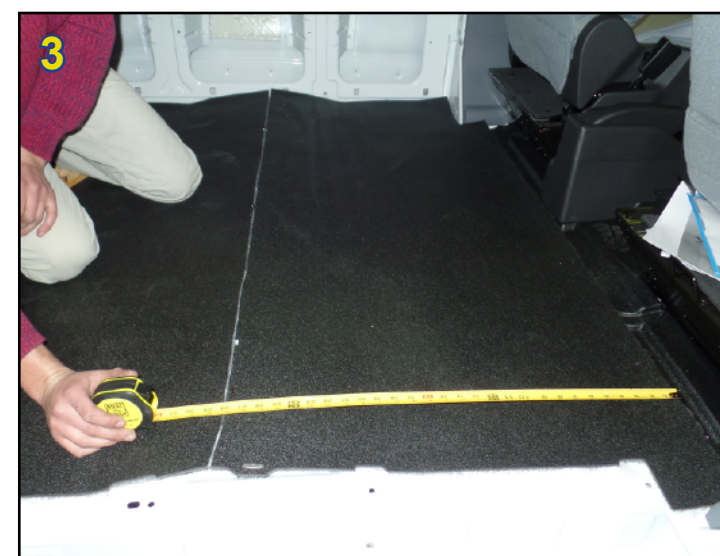
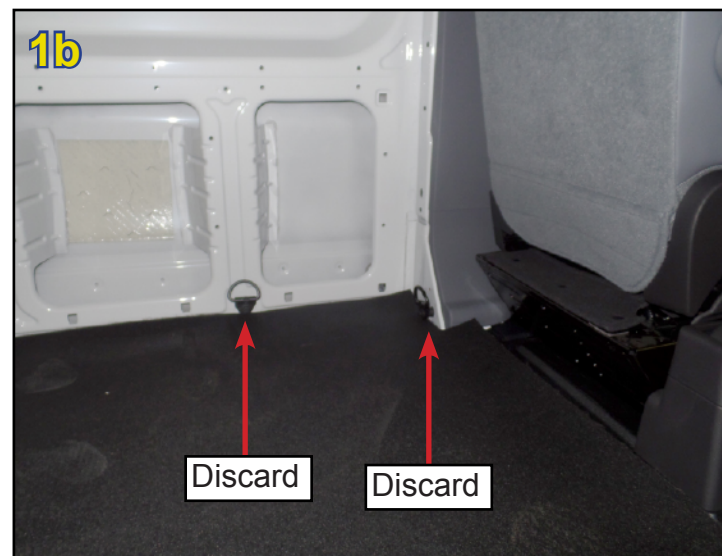

## CNG TANK INSTALLATION (LEFT TO RIGHT BEHIND FRONT SEATS)

4. Measure and mark drill point locations.  
Verify measurements.  
Drill appropriate sized holes.  
Deburr and rust proof.



Center PRD and wiring holes on the first rib from the wall.

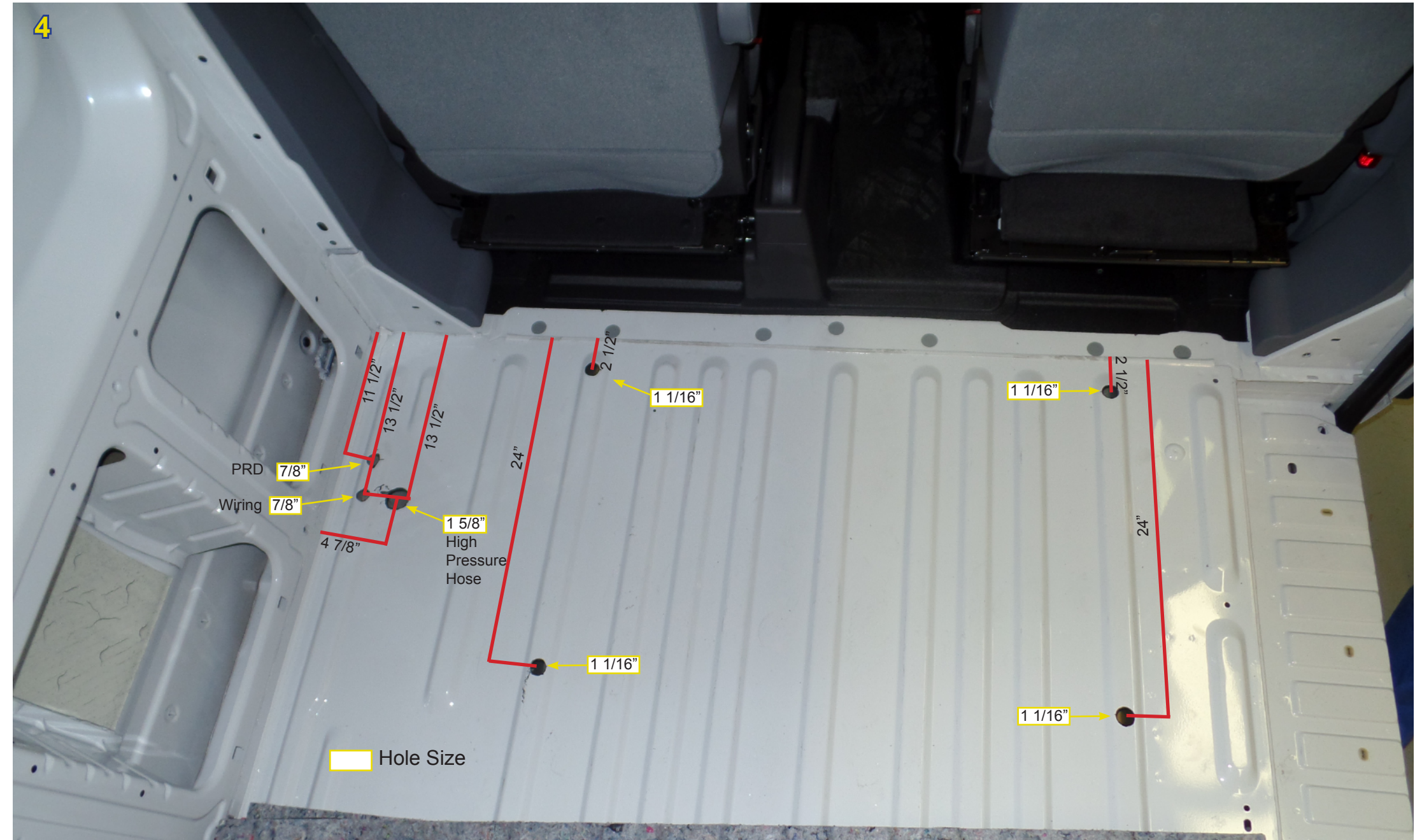

## CNG TANK INSTALLATION (LEFT TO RIGHT BEHIND FRONT SEATS)

5. Install four tube spacers (TR5TSP).
6. Install cylinder plate assembly (assembled with cylinder base brackets).  
Secure with four 6 1/2" bolts (235). Use backing plates underneath (SP3x3x3/16).  
Use 1/2-13 nylock nuts (043) and 1/2" washers (040).  
Bolt thread facing down.

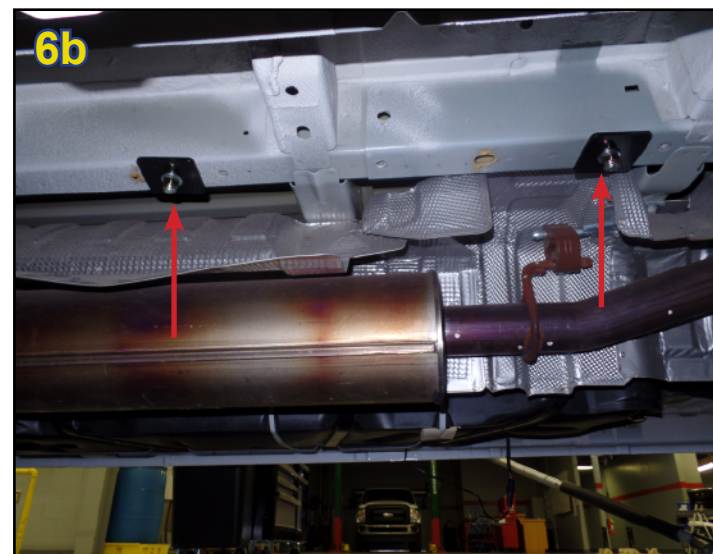
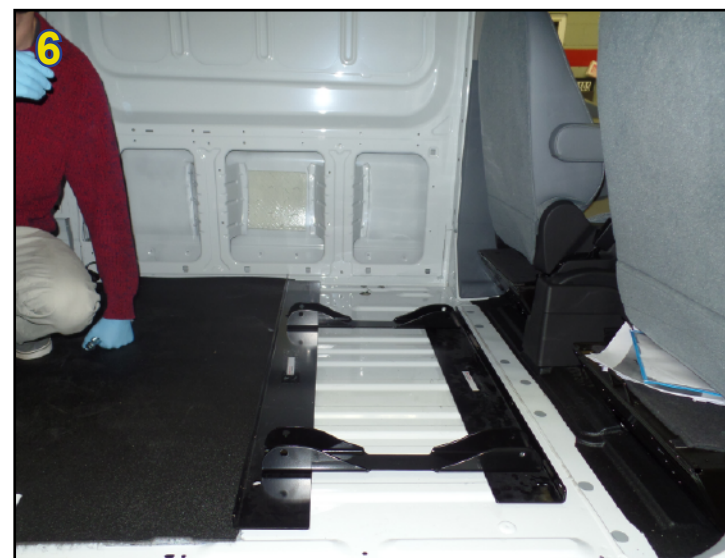
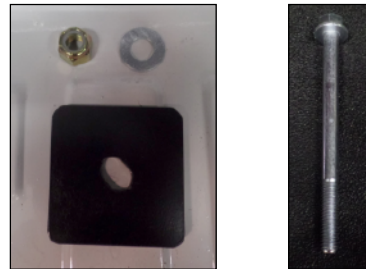
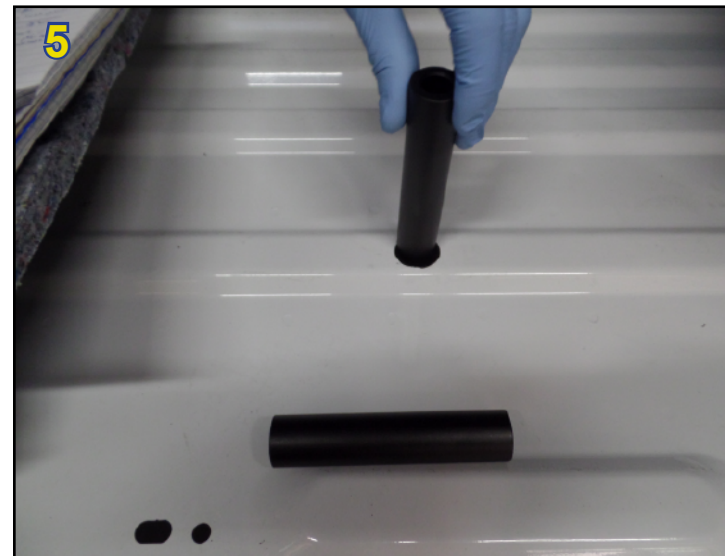

## CNG TANK INSTALLATION (LEFT TO RIGHT BEHIND FRONT SEATS)

7. Install cylinder straps.  
Use ring kit bolts and hand tighten, all four corners.
8. Place cylinder into place. Valve facing the driver side with solenoid facing the rear of the vehicle.  
Verify spacing is 6 1/2" from foam edge to cylinder ring.

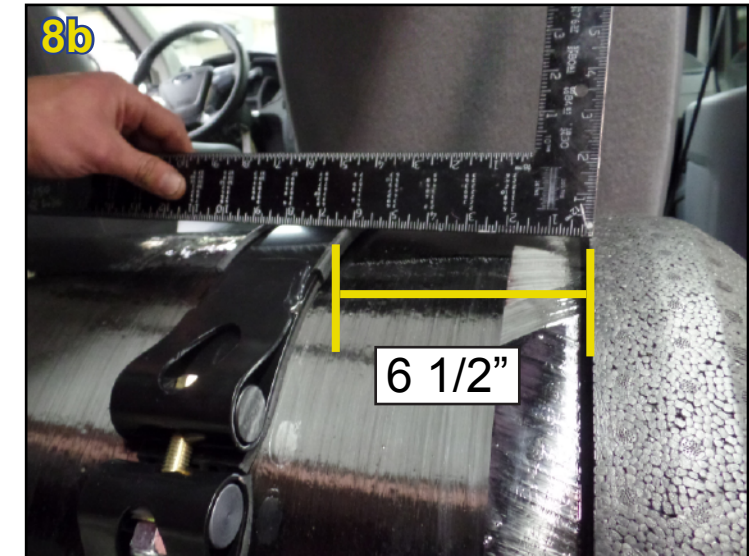

## CNG TANK INSTALLATION (LEFT TO RIGHT BEHIND FRONT SEATS)

9. Install grommets and fittings to the valve. Tighten fittings to 30-35 ft-lbs.  
Adjust cylinder as needed to ensure PRD tube is completely vertical.  
Tighten PRD tube by hand tightening first, then complete a full turn plus additional 1/4 turn.

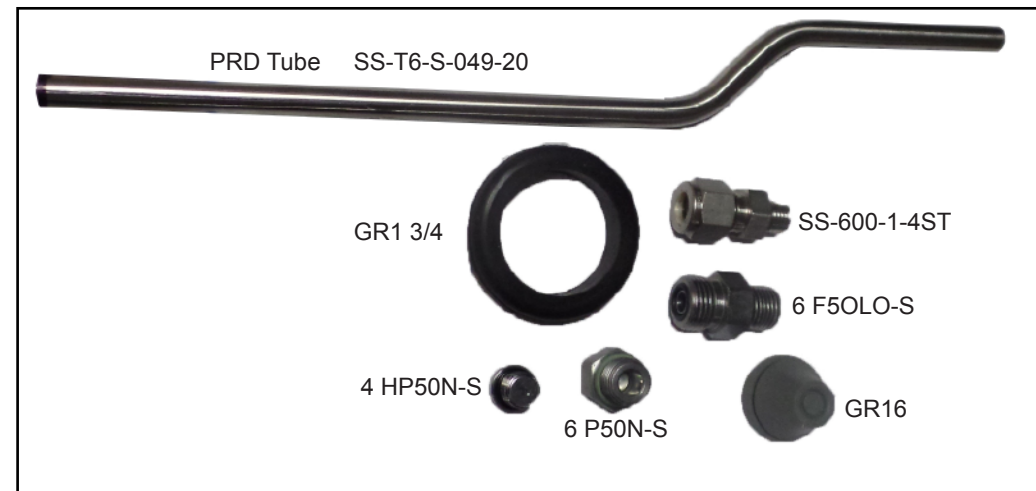
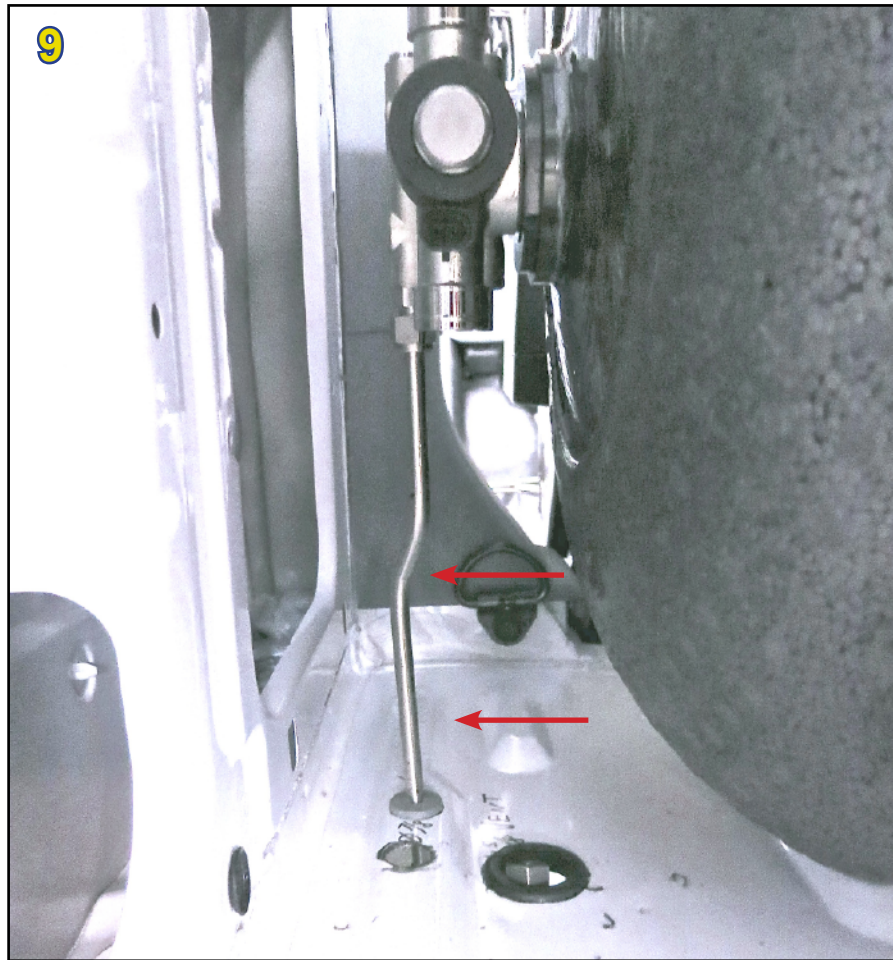



## CNG TANK INSTALLATION (LEFT TO RIGHT BEHIND FRONT SEATS)

10. Secure straps using bolts with the included factory cylinder strap kit.  
Tighten bolts to 45 ft-lbs.
11. Tighten the bolts connecting cylinder base bracket to rings. All four corners to 45 ft-lbs.
12. Run the vent tube (VT) through the grommet.  
Run the 27" high pressure hose through the vent tube. Connect hose to fitting and tighten to 30-35 ft-lbs.  
Ensure the 1 1/2" hose clamp is on the vent tube and tighten hose clamp AFTER a leak test has been performed.
13. Place PRD vinyl cap (VCPRD) below onto the PRD tube.  
Place vinyl sealing cap (VSVALVE) over plug. Place 1 1/2" hose clamp over the cap and tighten clamp AFTER a leak test has been performed.

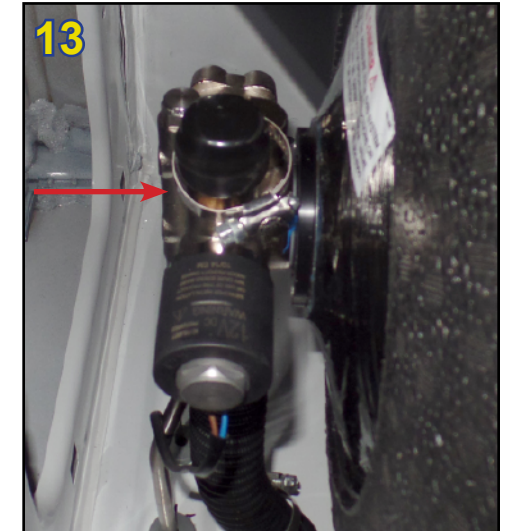
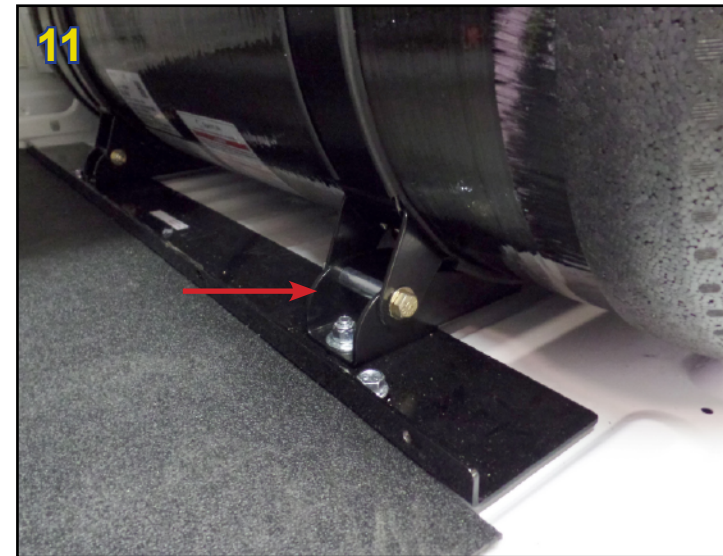

## CNG TANK INSTALLATION (LEFT TO RIGHT BEHIND FRONT SEATS)

14. Apply venting decal onto cylinder.  
Apply cylinder cover decal onto the strap closest to the valve.
15. Verify all connections tightened to specification.
16. Re-install step panel and anchor hook.



**⚠ DANGER ⚠**  
VENTING HIGH PRESSURE FROM THIS NATURAL GAS SYSTEM MUST BE DONE BY TRAINED PERSONNEL ONLY AND REQUIRES SPECIAL TOOLS AND INSTRUCTIONS THAT CAN BE OBTAINED FROM THE FUEL CYLINDER VALVE MANUFACTURER.



# BI-FUEL WIRE HARNESS DIAGRAM

- A. Main CNG Harness
- B. Fuel Rail Sensor Connector
- C. Positive Terminal Connector
- D. CNG Fuse Box
- E. CAN BUS Pigtail Connector
- F. Gauge Connector
- G. Rear Harness Connector
- H. Negative Terminal Connector
- I. CAN BUS Pigtail Harness
- J. Injector Jumper Harnesses
- K. Gauge Harness
- L. Rear Harness
- M. Solenoid Harness

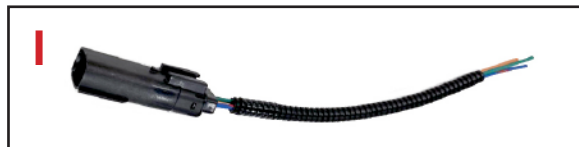
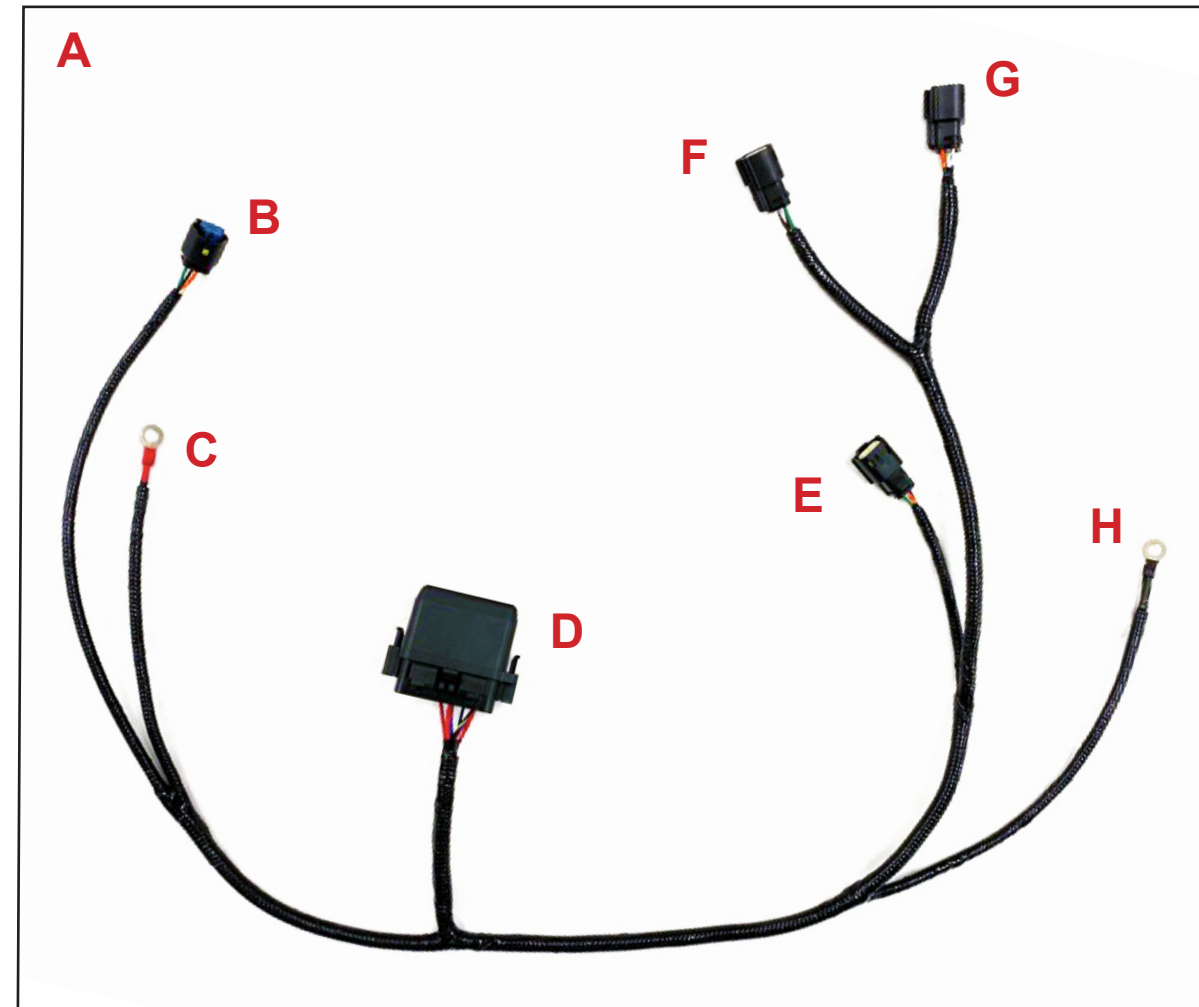

## CAN BUS PIGTAIL WIRE HARNESS INSTALLATION

1. Start by removing the driver side headlight. (2 screws and 3 Connectors).
2. Locate the PCM and disconnect the top and middle connector from PCM. Push the top connector and wires to the side.
3. On middle connector remove the black OEM tape, but save the tape to be reused later when complete.
4. On middle connector remove the protective cover (black).
5. On middle connector remove the and the lock cap cover (grey).
6. On middle connector locate **PIN 48** and remove the terminal with blue wire from connector. Splice/remove around 1/2" of insulation from the wire approximately 4" from terminal.
7. Twist the blue with red stripe wire from CAN BUS pigtail to the spliced blue wire and solder together.
8. Slide over the wire a 1" piece of heat shrink tubing and apply heat to shrink and protect the wires.

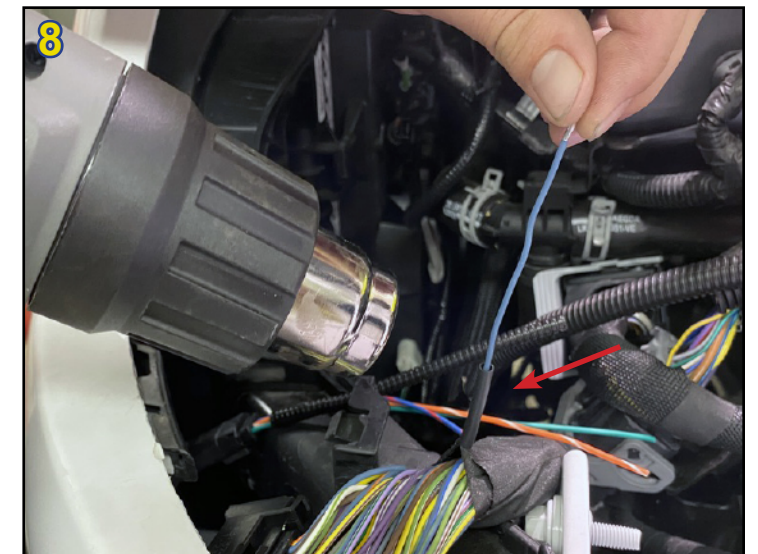
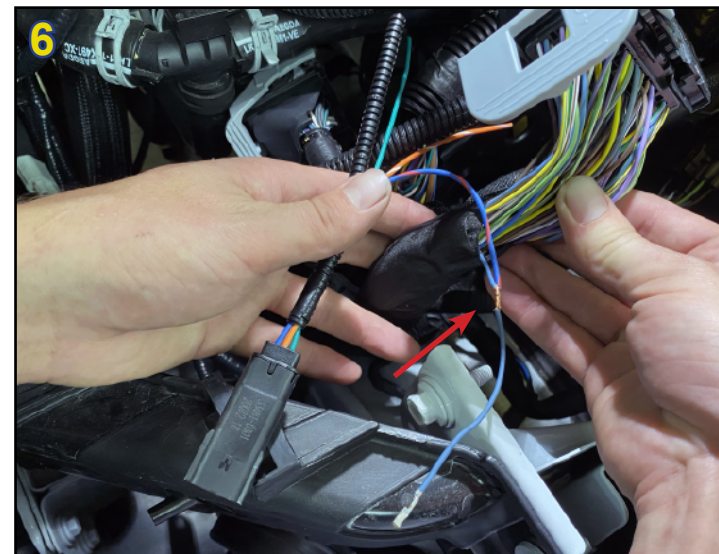
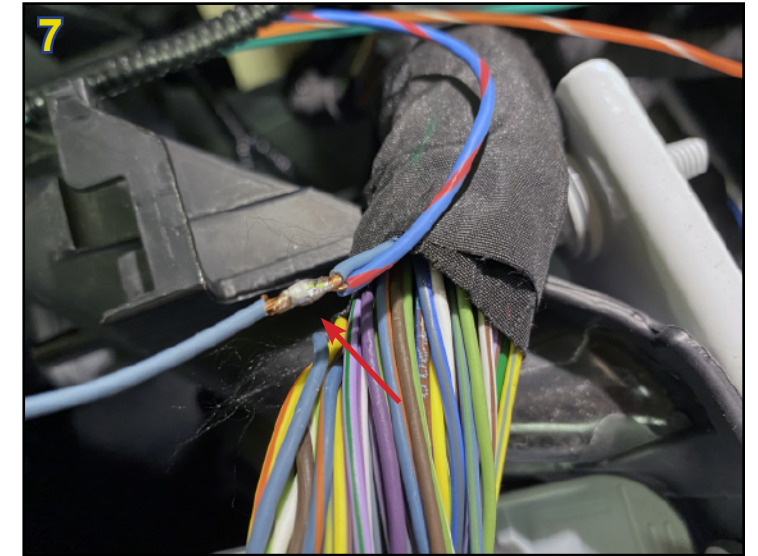
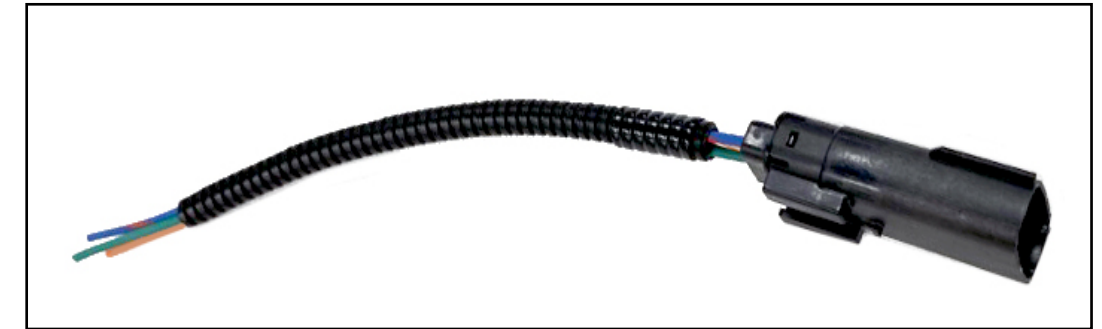

## CAN BUS PIGTAIL HARNESS INSTALLATION

9. Re-insert the blue wire terminal into the same location it was removed from on the connector.
10. Locate **PIN 115** and remove the terminal with the grey wire from same PCM middle connector. Connect the green wire from the CAN BUS pigtail harness to the grey wire. Follow same steps as before by splicing, twisting together, soldering and heat shrinking the wires.
11. Locate **PIN 31** with green wire (do not remove the terminal). Cut the green wire approximately 3" from the PCM connector.
12. The OEM harness side of cut green wire will not be used, heat shrink to seal and protect.
13. Slide heat shrink tubing over the orange with white stripe wire from CAN BUS pigtail harness and then connect to the green wire from PCM connector. Solder and heat shrink to seal and protect.
14. Attach the loom over the CAN BUS pigtail harness.
15. Re-install the grey and black protective covers on the pcm connector. Be careful to not have any wires get pinched by covers.
16. Re-apply the OEM tape saved over the wires and CAN BUS pigtail.
17. Re-install the two PCM connectors to the PCM.
18. Later on the CAN BUS pigtail harness connector will be connected to the CNG main harness. Leave headlight assembly out for gauge harness installation.

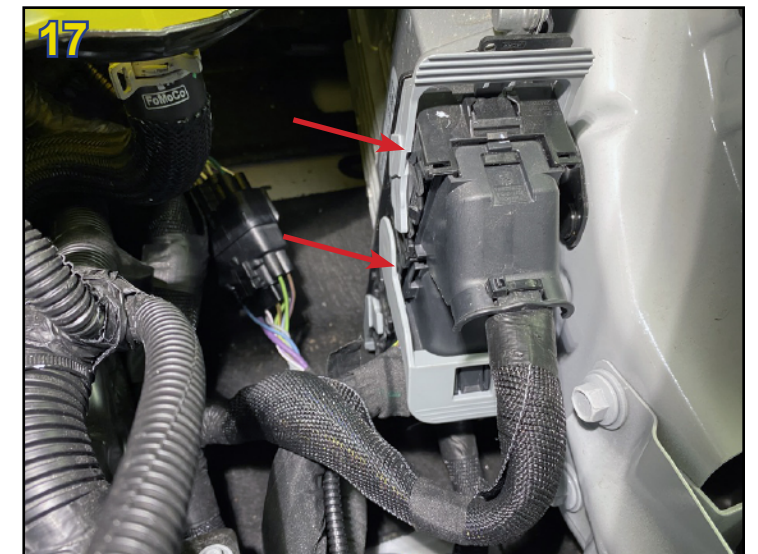
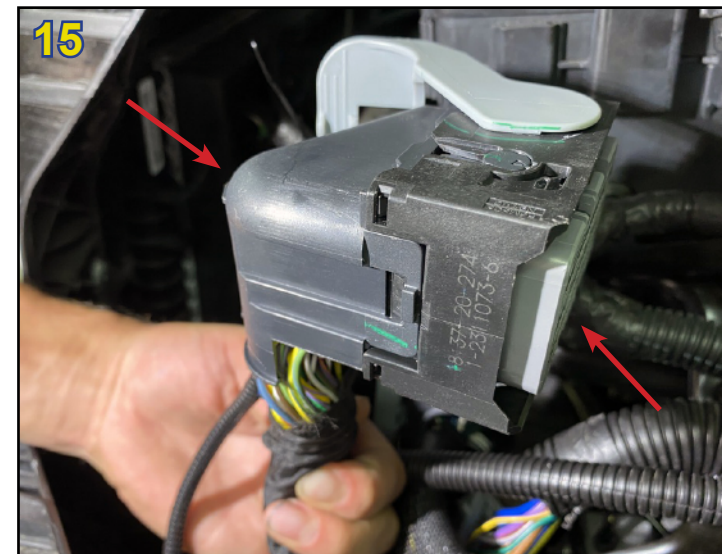
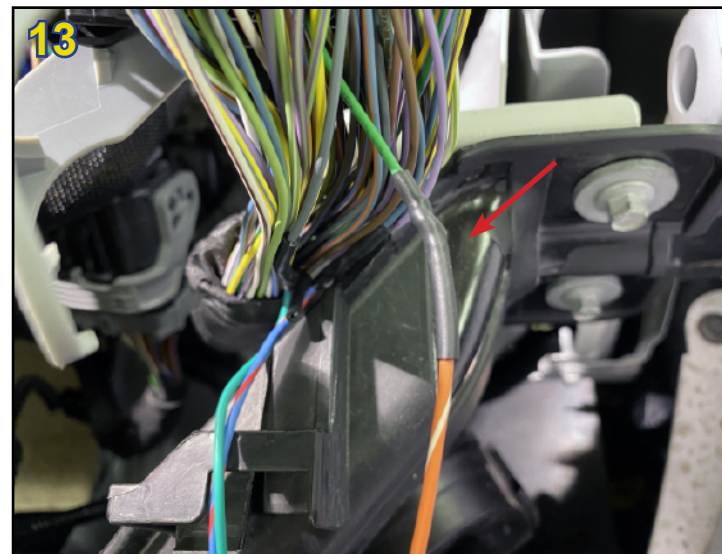
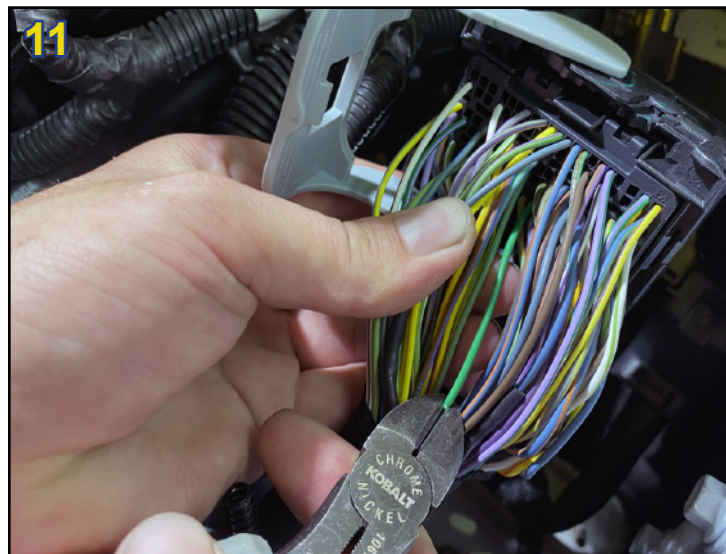
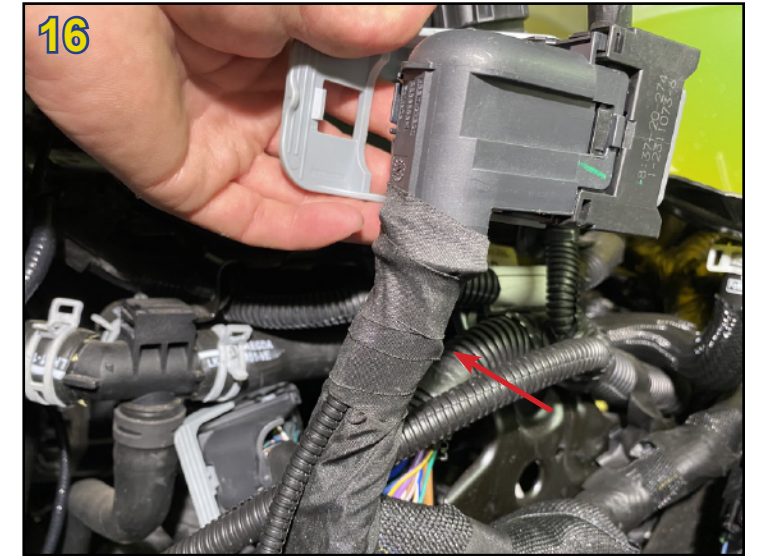
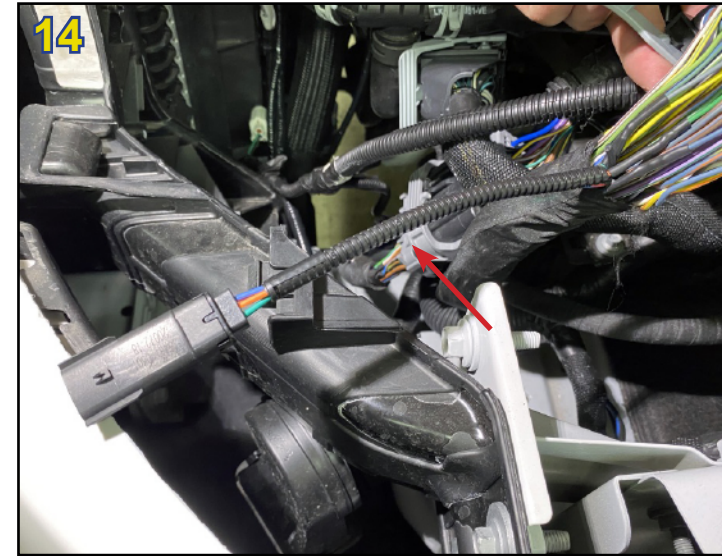
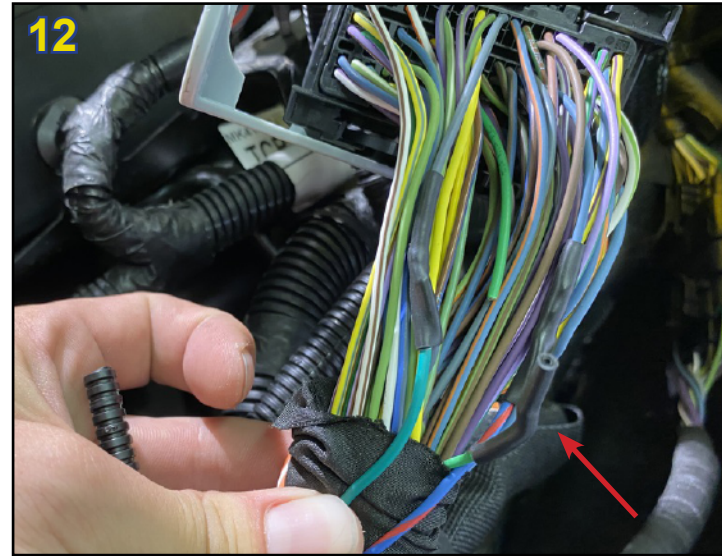
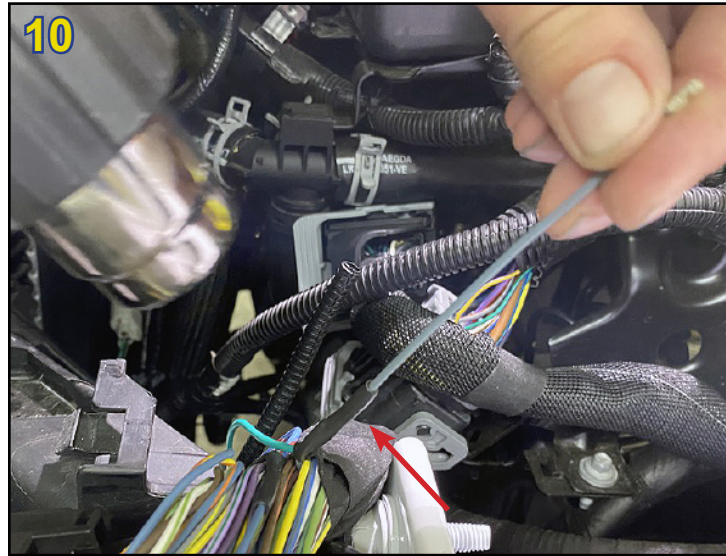

## MAIN WIRE HARNESS INSTALLATION

1. Start by installing the fuse box bracket. Use the two self tapping screws and secure to plastic framing near the OEM fuse box.
2. Lay the main wire harness over engine with the sensor connector and positive ring terminal end running towards intake manifold. Then connect the fuse box to the fuse box bracket.
3. Connect the fuel rail sensor connector to the gasoline fuel rail sensor.
4. Remove the OEM red positive post cover, loosen nut, slide the positive ring terminal from main harness on bolt and tighten the nut. Reattach the OEM cover.
5. Connect the negative ring terminal on main wire harness to the OEM bolt under the OEM PCM.
6. Connect the pigtail connector on main harness to the pigtail connector at OEM PCM.

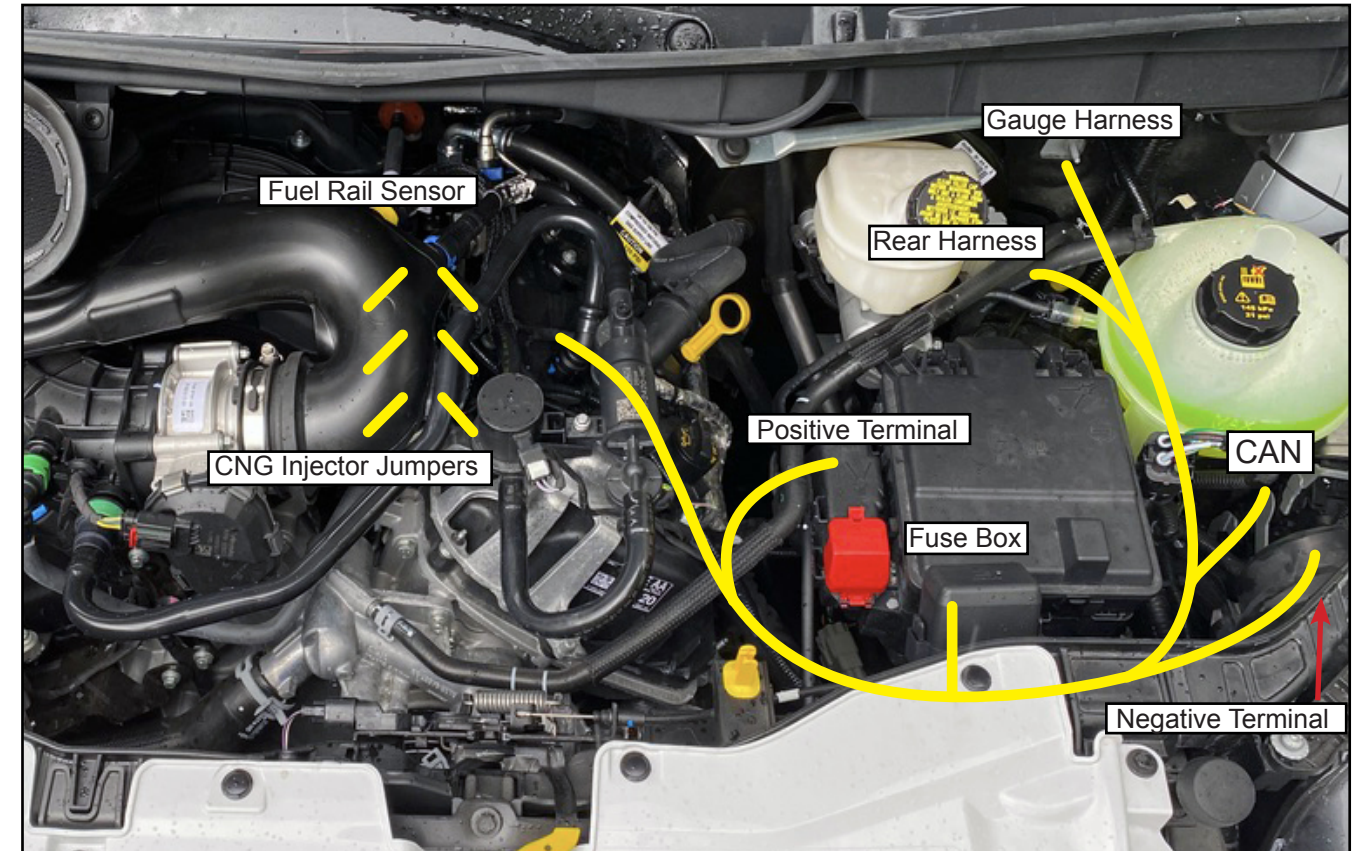
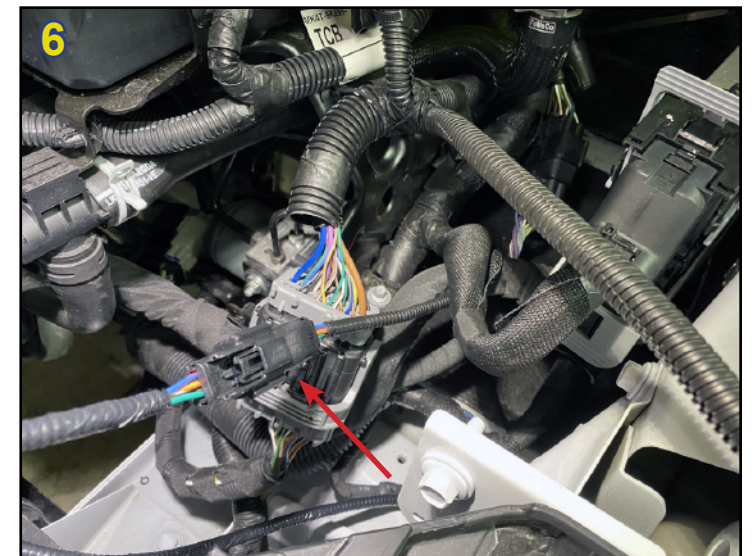
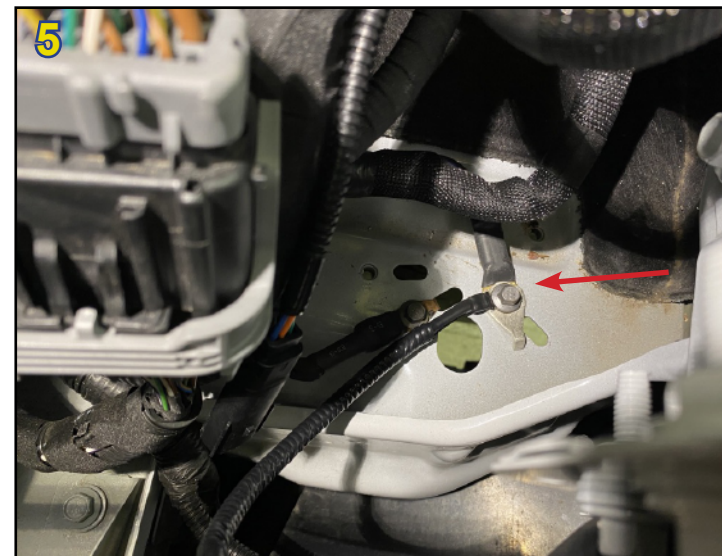
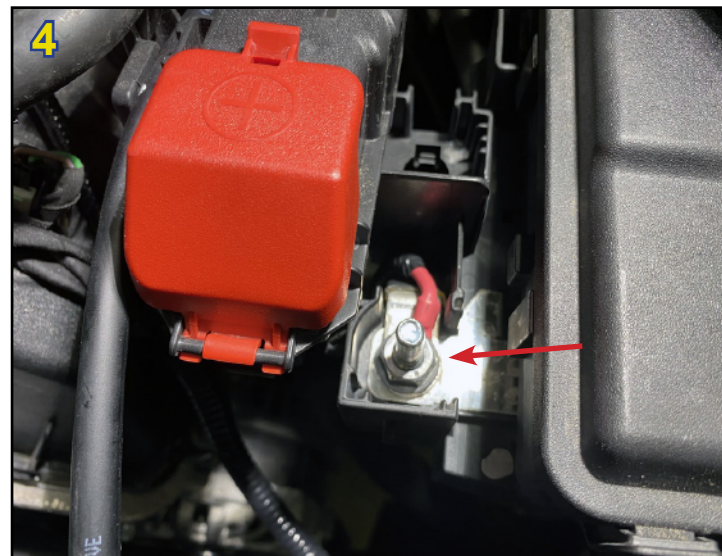
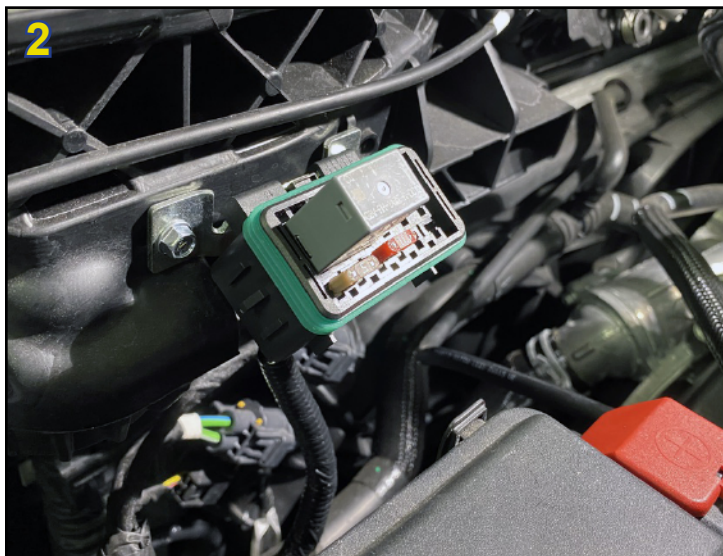
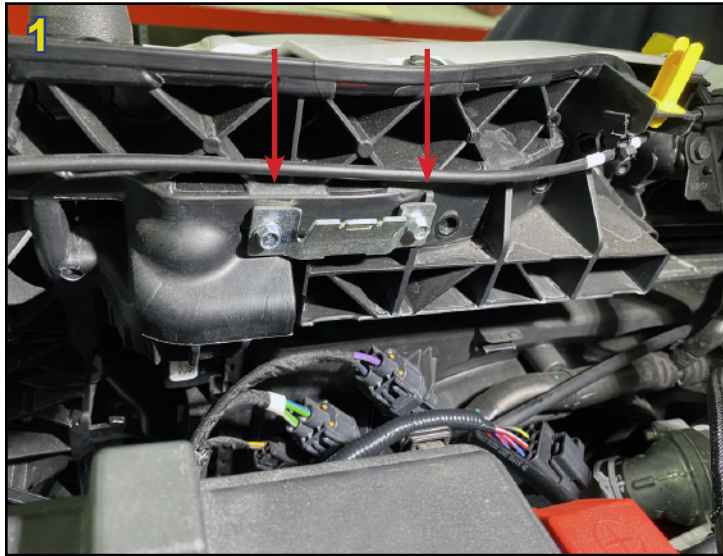

## MAIN WIRE HARNESS INSTALLATION

7. Connect the rear harness connector on main harness to the rear harness connector coming from regulator assembly.
8. Connect the CNG gauge connector on main harness to the gauge harness connector. Leave headlight assembly out for gauge harness installation.
9. Zip tie all wiring to the OEM wiring harnesses. There is to be no loose or hanging wires. Be sure to zip tie to areas as to avoid any wear, abrasions or moving parts. Pictures only show some of locations for zip ties. Secure wire harnesses with zip ties as needed.

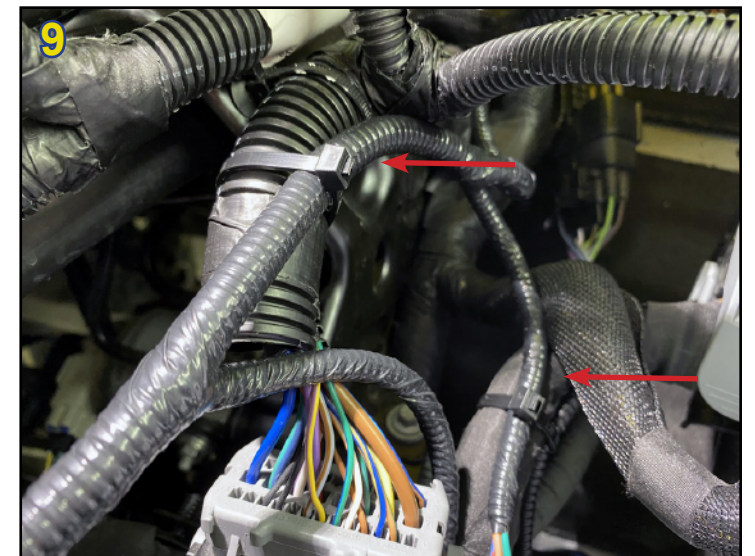

## REAR WIRE & SOLENOID WIRE HARNESS INSTALLATION

### REAR WIRE HARNESS INSTALL

1. Under the vehicle, driver side. Connect the rear wire harness sensor connector to the tank pressure sensor on the regulator assembly.
2. Connect the rear wire harness solenoid connector to the solenoid harness coming from the tank package.
3. Route the rear wire harness towards engine compartment along the same path as the low pressure natural gas hose.
4. Zip tie all wiring to the OEM wiring harnesses. There is to be no loose or hanging wires. Be sure to zip tie to areas as to avoid any wear, abrasions or moving parts.

### SOLENOID WIRE HARNESS

1. Connect the solenoid connector to the rear harness connector. Route the solenoid wire harness along same path as low pressure hose going to the tank valve in cargo area of van. Route the wire harness through the opening in floor of van and seat the grommet and connect to the solenoid on tank valve. Zip tie all wiring to the OEM wiring harnesses or low pressure hose. There is to be no loose or hanging wires. Be sure to zip tie to areas as to avoid any wear, abrasions or moving parts.

Note: Solenoid harness location will change depending on cylinder package being installed.

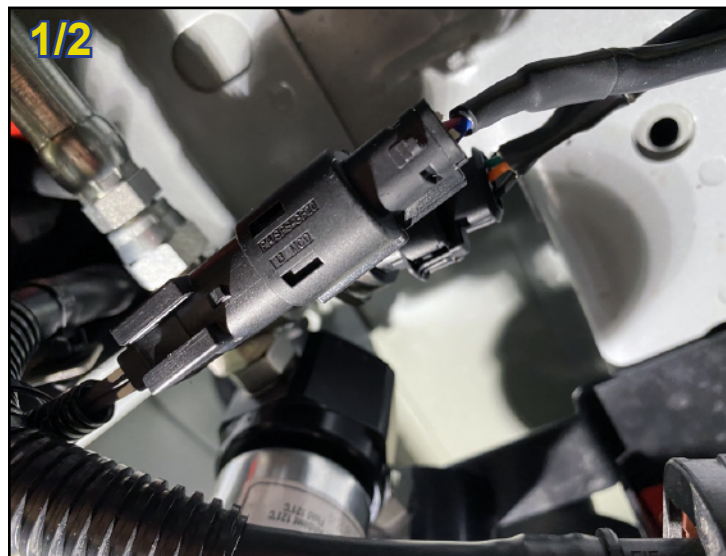



## FUEL GAUGE WIRE HARNESS INSTALLATION

1. Start by removing the driver side headlight assembly if not already removed.
2. Remove the 2 bolts on the coolant reservoir and move the reservoir to the side.
3. Locate the rubber grommet at fire wall. Push the grommet inwards and feel behind the wall to prepare for drilling a hole. Make sure there is no wires in the way prior to drilling the hole for the gauge wire harness.
4. Drill a 7/8" hole in fire wall approximately 1" from the OEM hole that rubber grommet was on. Deburr and paint hole.
5. Route the gauge wire harness end with 2 connectors through the drilled hole.
6. Spray silicon on the grommet on wire harness and push into to the hole to be seated.
7. Pull the OEM large rubber grommet back into original location.
8. Connect the gauge wire harness connector to the main harness.
9. Zip tie all wiring to the OEM wiring harnesses. There is to be no loose or hanging wires. Be sure to zip tie to areas as to avoid any wear, abrasions or moving parts.
10. Reinstall the coolant reservoir and headlight assembly.

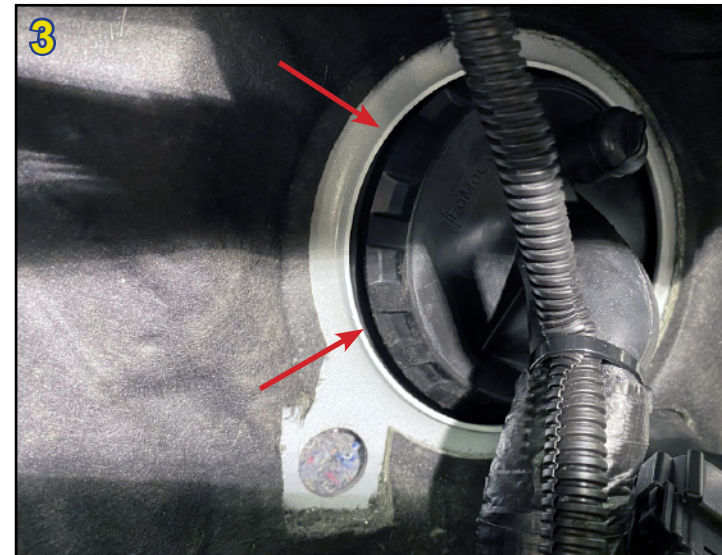

## FUEL GAUGE INSTALLATION

1. Start by removing the cover located under the driver steering wheel.
2. Remove the cup holder.
3. Remove the handle on a-pillar. (2 bolts under the caps)
4. Route the gauge wire harness from the fire wall up and through the cup holder. Zip tie all wiring to the OEM wiring harnesses. There is to be no loose or hanging wires. Be sure to zip tie to areas as to avoid any wear, abrasions or moving parts like the steering wheel mechanisms.
5. Get the fuel gauge pod and drill and enlarge the oem hole to 5/8". This is to allow the gauge wire harness connector to fit through.
6. Remove the red double sided tape.
7. Slide the directional rubber gasket over the double sided tape. **IMPORTANT:** the direction of the gasket seals are important. See picture.

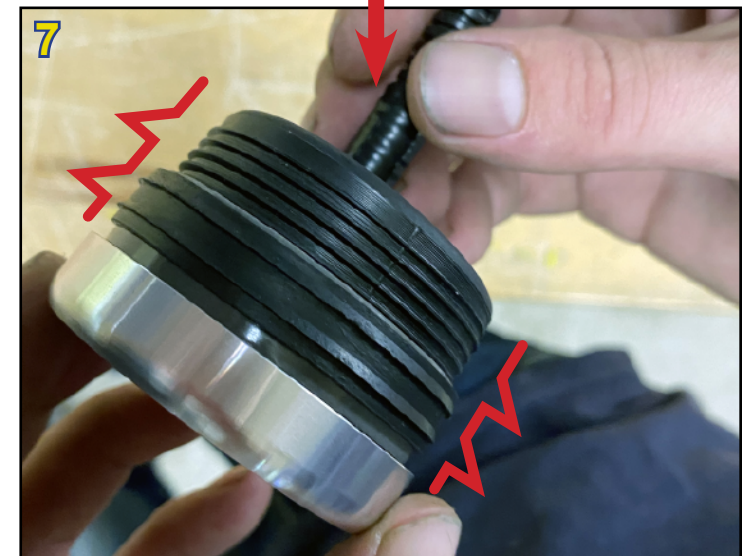
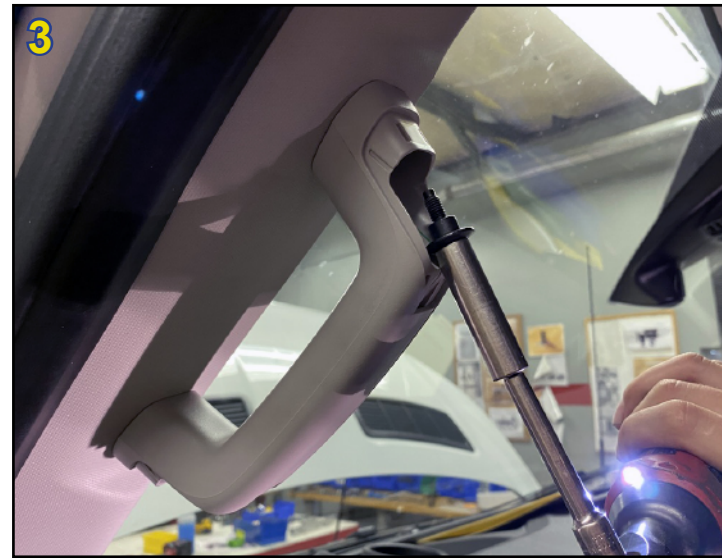

## FUEL GAUGE INSTALLATION

8. Get the gauge and feed the gauge wires and connector through the enlarged hole on fuel gauge pod. Do not push the gauge into the pod yet.
9. Remove the double sided sticky tape cover from bottom of the fuel gauge pod.
10. Position the gauge on the a-pillar as in picture and attached. Mark on the a-pillar the two pod base screw hole locations with a marker.
11. Remove the a-Pillar, disconnect the speaker wires and any rubber seals as needed.
12. Use the 2 screws provided with gauge and attach to the a-pillar. Then drill a 3/8" hole in the a-pillar for the gauge wires to go through. Be careful not to drill through or damage any wires on a-pillar. Feed the gauge wire connector through hole on a-pillar.
13. Get the wire at cup holder and feed back through and up to the a-pillar.
14. Get the a-pillar, hold into original position, then connect the gauge wire harness and gauge connectors together. Re-connect the speaker wiring. Snap the a-pillar back into original position and reattach any rubber seals previously removed around door. Position the gauge and push it into the gauge pod until secured. Reattached the cover under steering wheel.

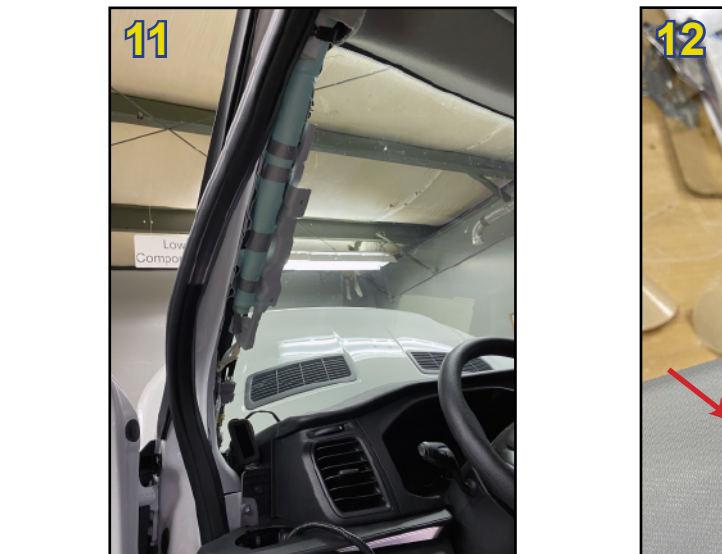

## UNDERHOOD FUEL DELIVERY INSTALLATION - DISASSEMBLE

1. Start disassembly by removing the vacuum assembly bolt.
2. Disconnect the three vacuum tube connectors (green, yellow and blue). Push the hoses to the side and out of the way.
3. Disconnect the throttle body wire connector.
4. Disconnect the vacuum hose connector (green).
5. Remove the air intake modular assembly by loosening the clamp screw on each end. Set to the side.
6. Remove top bolt and set to side, then loosen the bottom bolt but do not remove. Leave loose so bracket moves.
7. Disconnect the sensor wire connector (white).
8. Remove the four bolts from PVC valve tube assembly. Set the tube assembly to side with the four bolts.
9. Disconnect the vacuum hose connector (blue).

**DO NOT USE POWER TOOLS!**

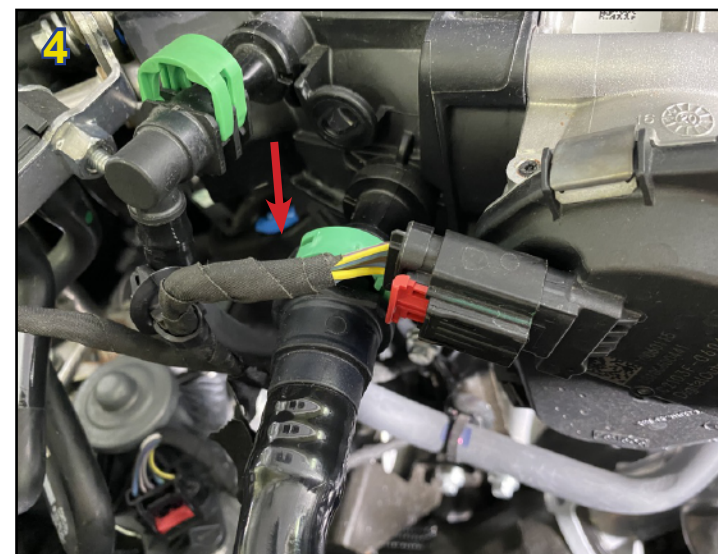
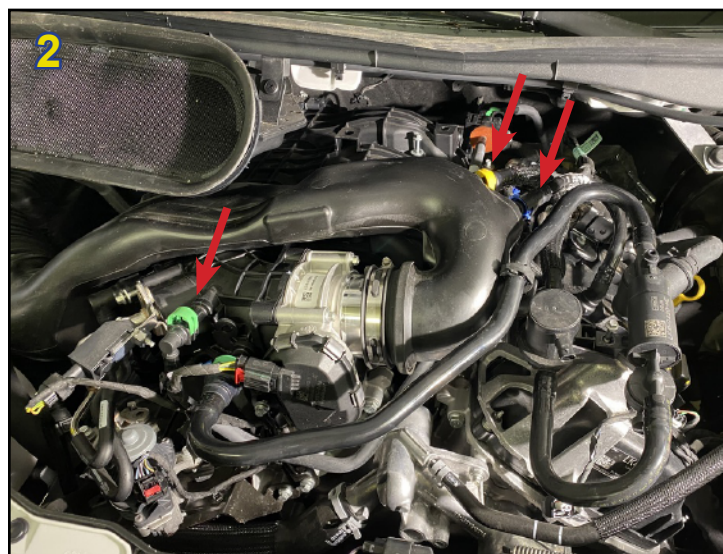
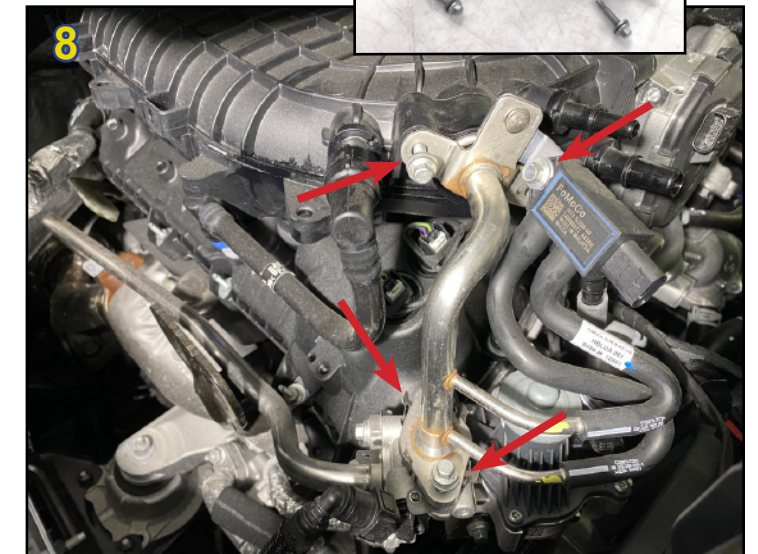
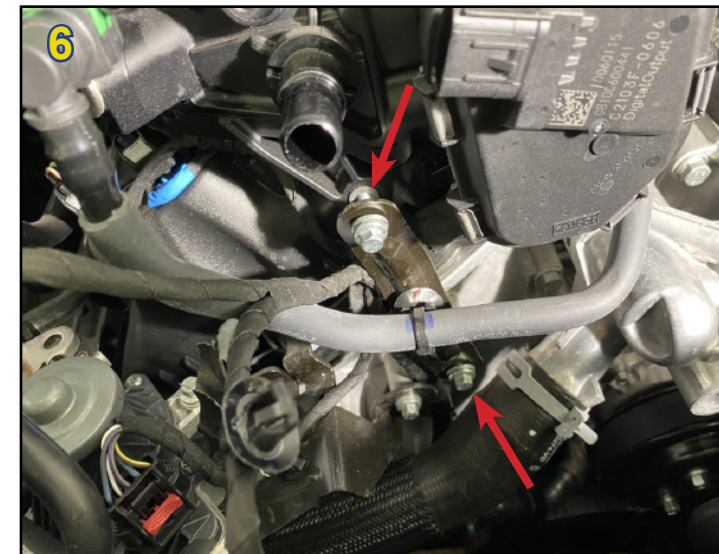
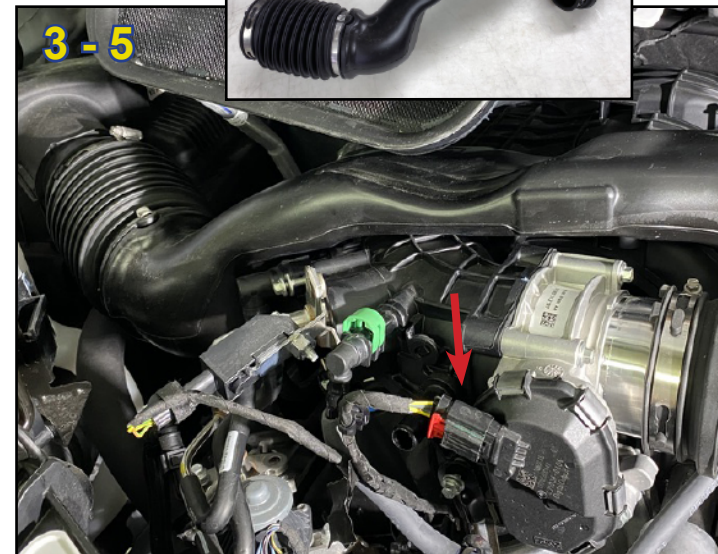

## UNDERHOOD FUEL DELIVERY INSTALLATION - DISASSEMBLE

10. Disconnect the white wire connector and green vacuum hose connector near back of engine close to fire wall. Set hose to side.
11. Disconnect the two white connectors on fuel tube and set to the side.
12. Disconnect blue fuel line connector and push to the side. Be careful for gasoline in the fuel line.
13. Remove the eight bolts from the intake manifold (two on top and six on the bottom).
14. Disconnect the MAP sensor connector from intake manifold towards fire wall.
15. Disconnect the fuel rail pressure sensor connector.
16. Remove the intake manifold and set to the side with the eight bolts.
17. Remove the four bolts from fuel rail and the six gasoline injector wire connectors. Set the fuel rail and six bolts to the side. Disassembly is complete.

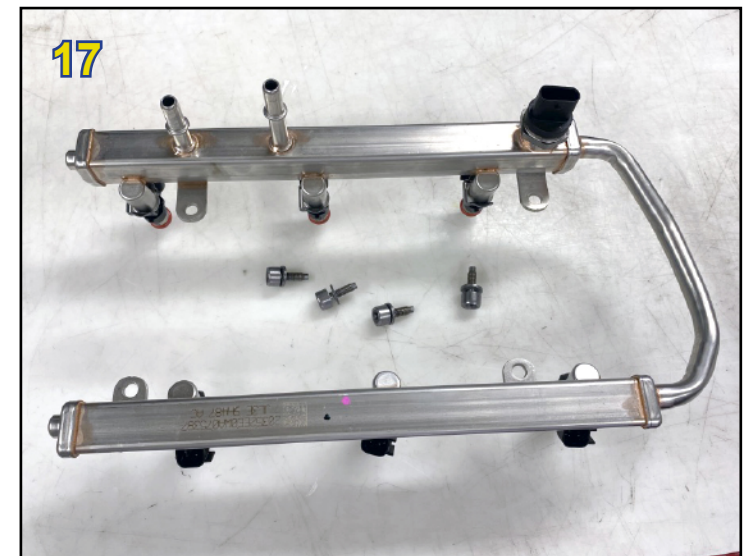
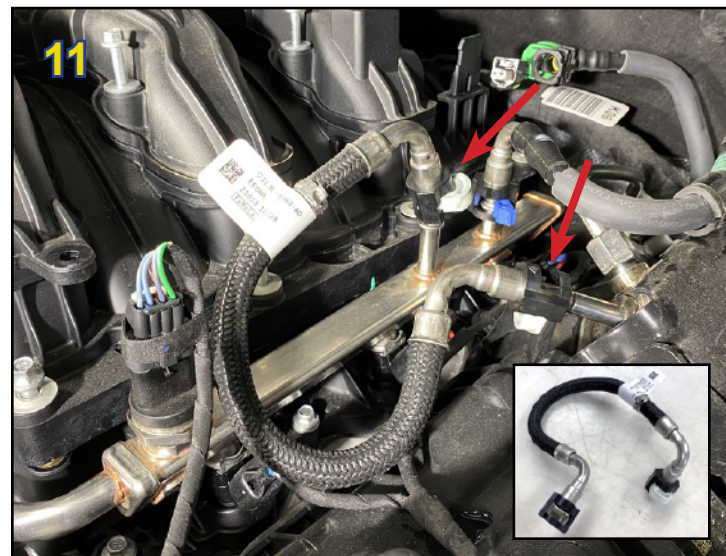
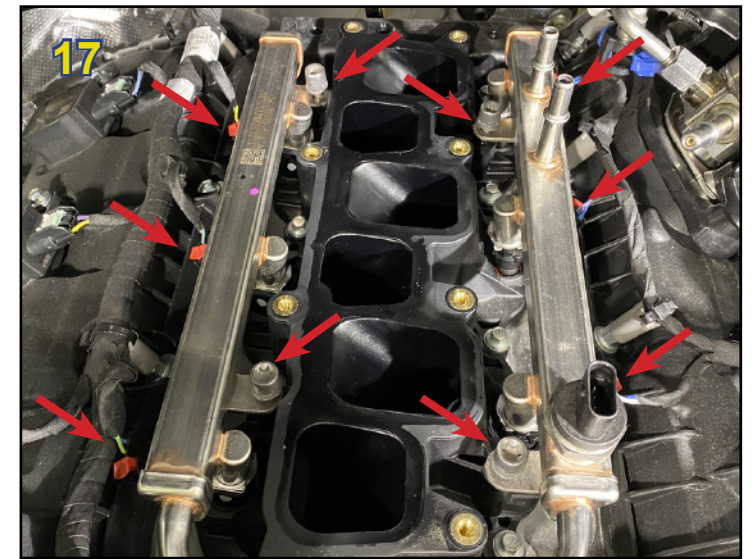
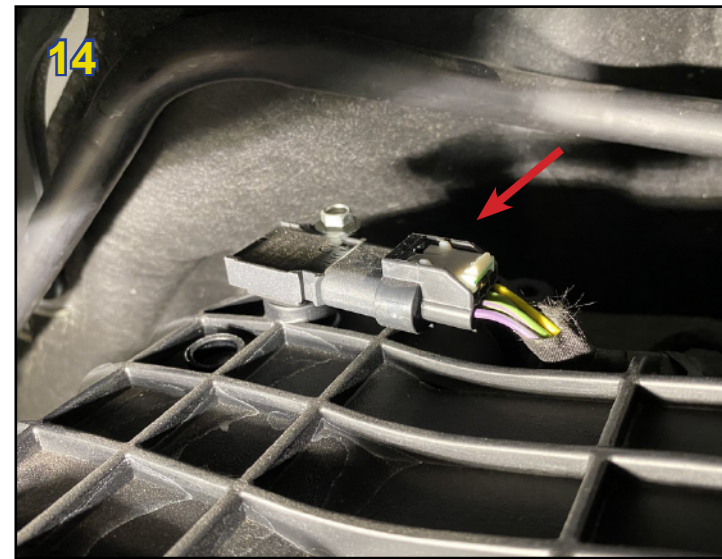
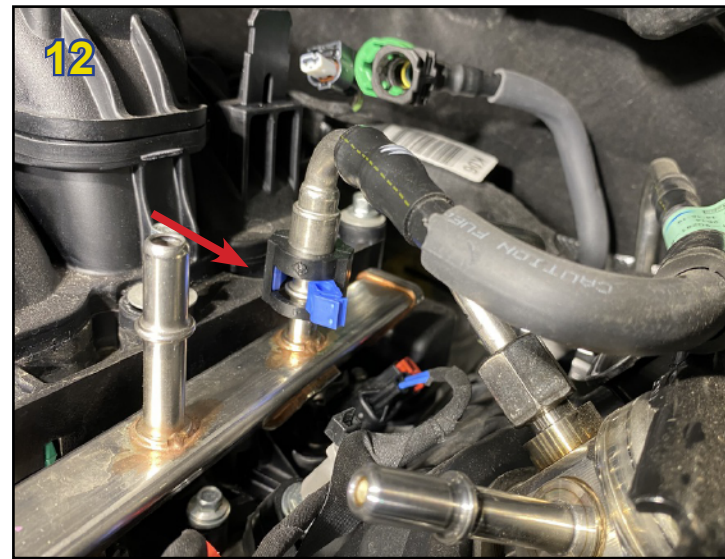
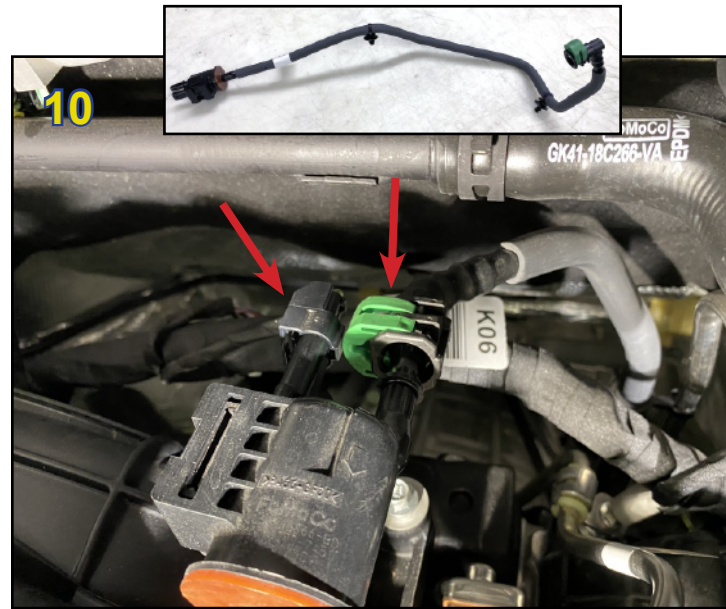
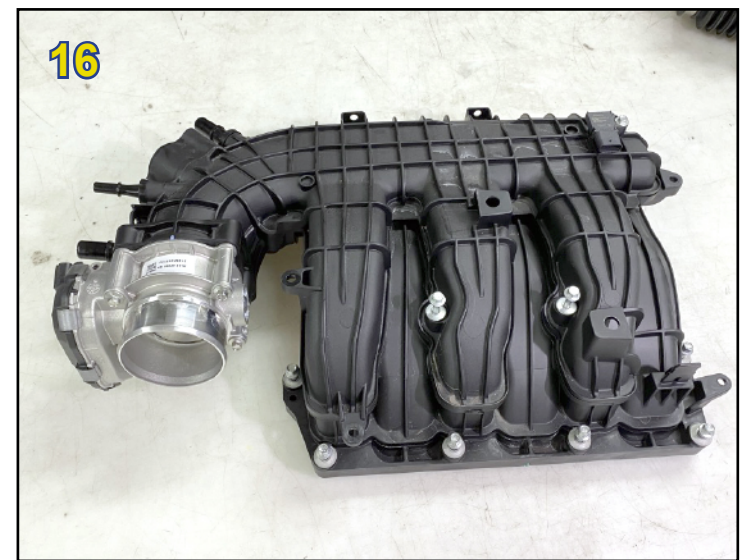

## UNDERHOOD FUEL DELIVERY INSTALLATION - ASSEMBLE

1. Remove the six gasoline injectors and one sensor from OEM gasoline fuel rail.
2. Remove the o-rings from the natural gas injectors.
3. Remove the o-rings from gasoline injectors.
4. Install gasoline injector o-rings on the natural gas injectors.
5. Insert the natural gas injectors into the gasoline fuel rail with wire connectors facing outside the fuel rail.
6. Install the natural gas sensor with o-ring gasket to the fuel rail.
7. Attach the #8 fitting and #6 fitting to the stems on gasoline fuel rail.
8. Connect the six injector wire jumpers to each natural gas injector, you will hear a click when properly attached.
9. Spray silicon or o-ring lube on the natural gas o-rings and re-install the fuel rail on engine by sliding the natural gas injectors into the injector ports on the engine and securing with the four OEM bolts.
10. Connect all six natural gas jumper wires to the OEM injector wire harness connectors.

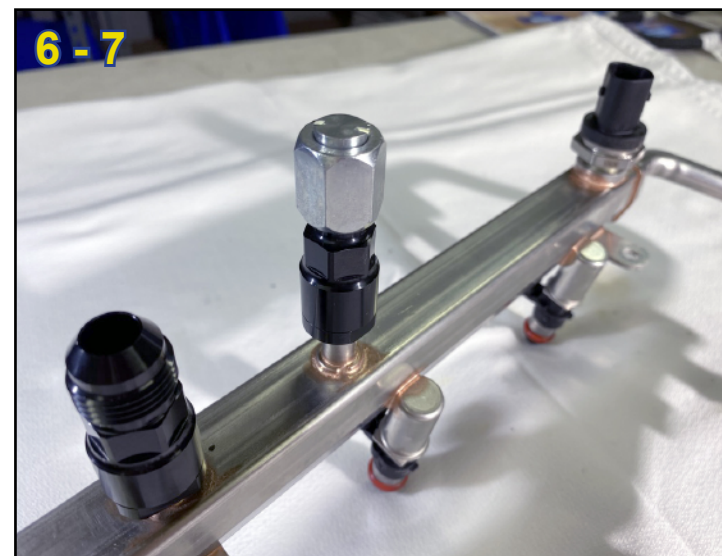
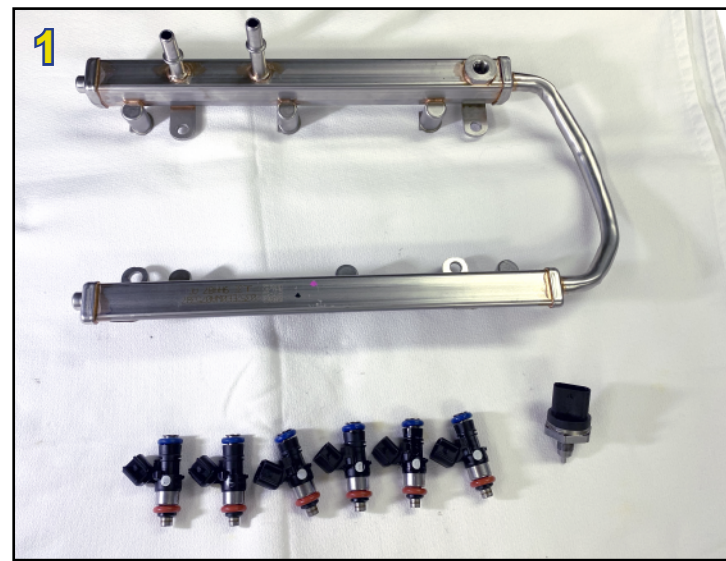

## UNDERHOOD FUEL DELIVERY INSTALLATION - ASSEMBLE

11. Find gasoline block from kit and o-ring gasket. Find the OEM gasoline sensor previously removed.
12. Install the OEM gasoline sensor with provided o-ring gasket to gasoline block.
13. Install and tighten the gasoline block fitting to the gasoline fuel pump.
14. Connect the fuel line with blue connector to the gasoline block fitting and connect the OEM gasoline fuel rail wire harness connector to sensor on gasoline block.
15. Re-install the OEM intake manifold and secure the eight OEM bolts. Two bolts on the top and six bolts on the bottom of manifold.
16. Re-install the OEM purge valve assembly and secure with the four OEM bolts. Re-connect the white wire connector to sensor.
17. Re-install the top bolt on bracket and tighten the bottom bolt left loose earlier on bracket.
18. Re-connect the wire harness white connector to map sensor near back of manifold.
19. Now is the best time to connect to low pressure natural gas fuel line, if not already completed. Refer to low pressure fuel line installation section if needed.
20. Re-install the vacuum tube connectors and wire connectors along with the wire harness connector to the throttle body.
21. Re-install the air intake modular by securing the clamp screw at each end.

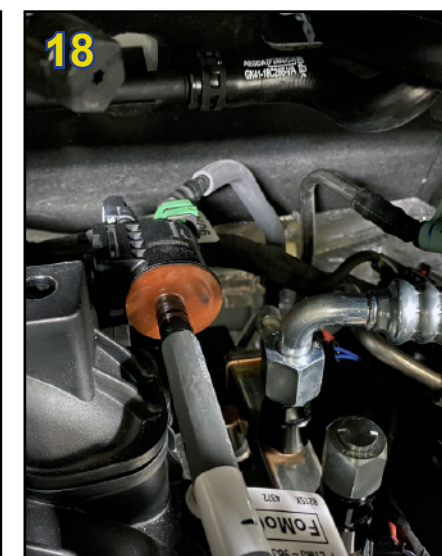
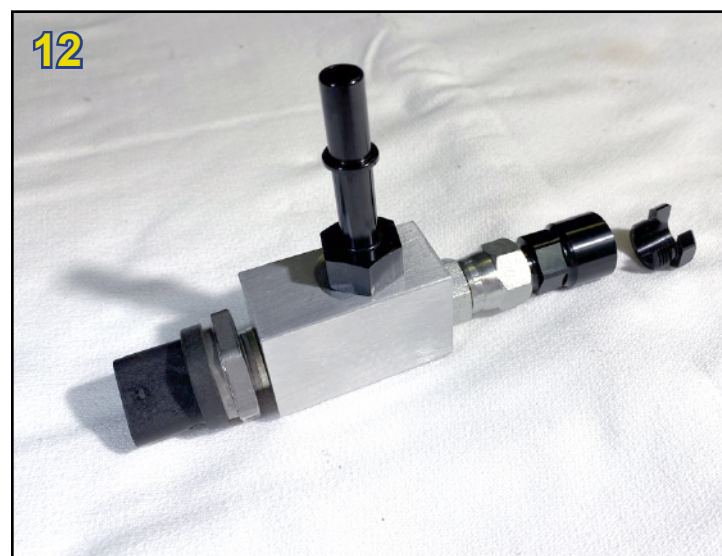
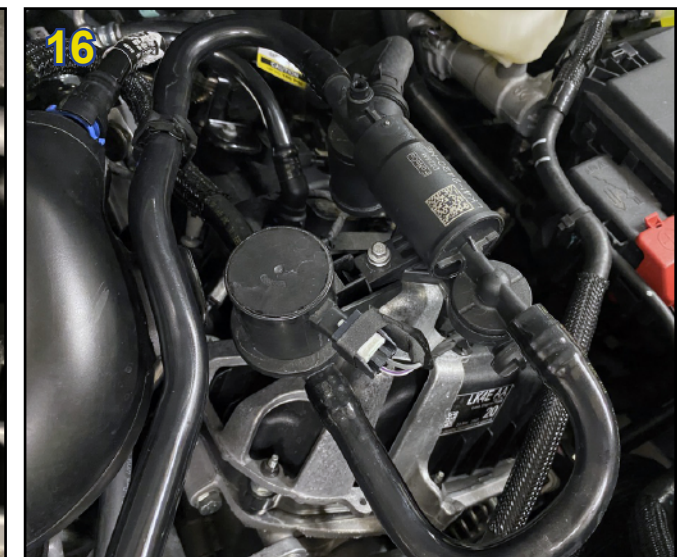
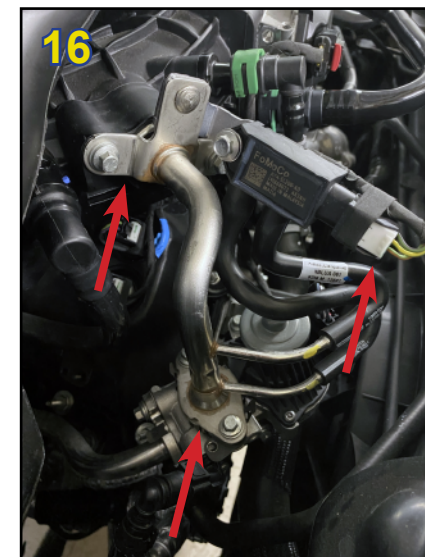
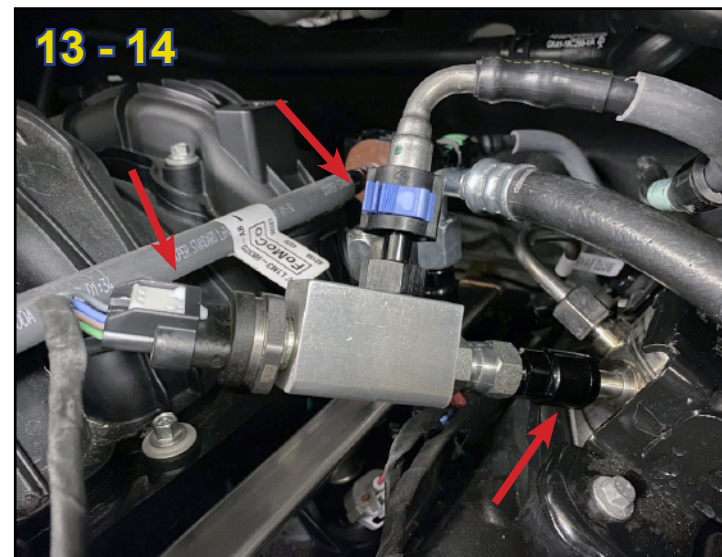
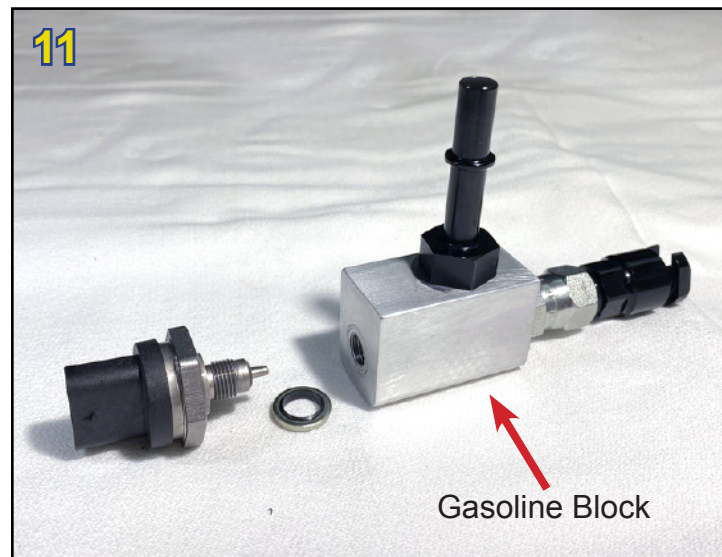

## FUEL FILL INSTALLATION

1. Loosen OEM fuel neck below.
2. Remove trim.
3. Remove bottom cap panel.
4. Retrieve the Jig. (sold separately)

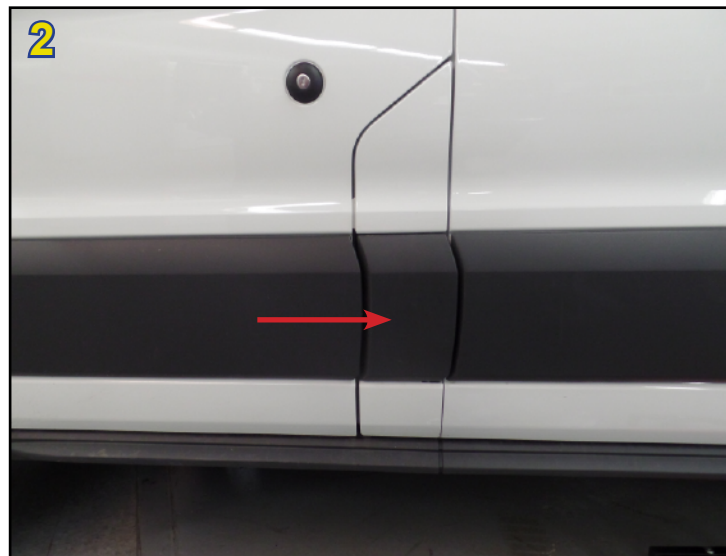

Jig

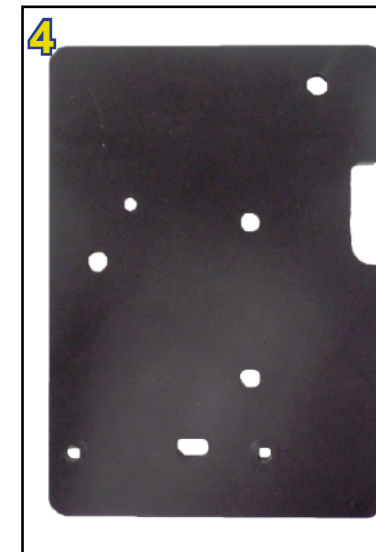



## FUEL FILL INSTALLATION

5. MODIFY THE COLUMN.  
Attach jig to column where shown with two screws into two OEM holes.  
Drill three 17/64" holes. Remove jig. Deburr and rust proof.
6. MODIFY COLUMN #2.  
Place jig behind wall into column and secure.  
Cut out 1 3/4"-2" opening. Deburr and rust proof.
7. Slightly bend the second layer within the column.  
Rust proof any chipped paint.

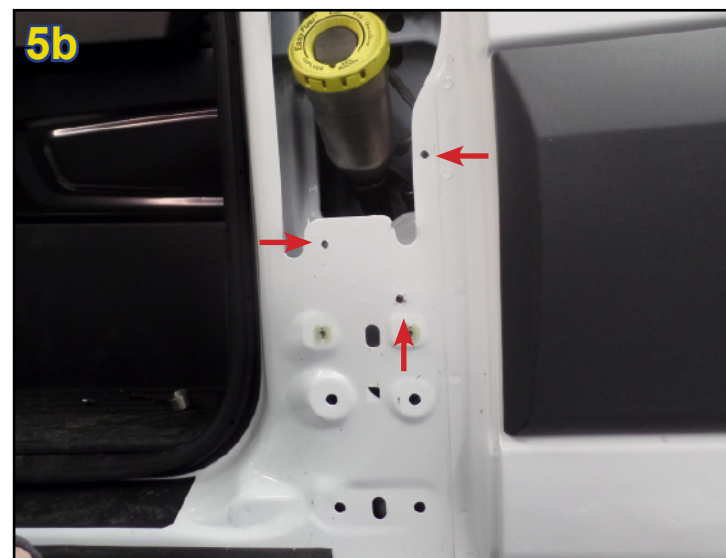
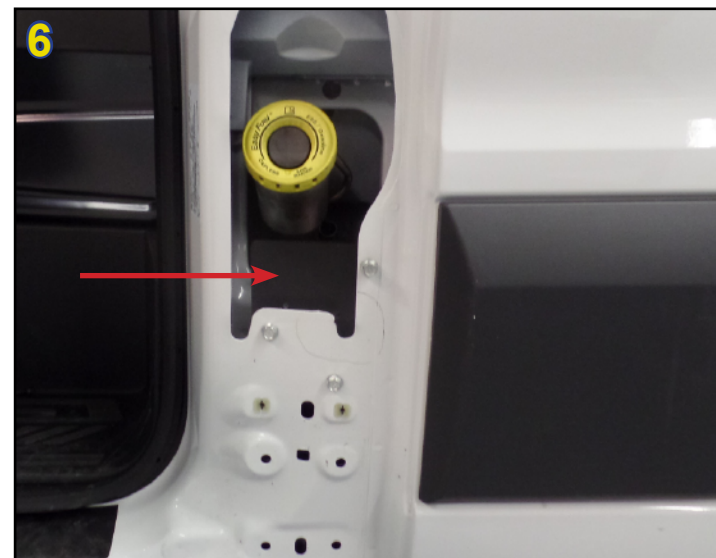
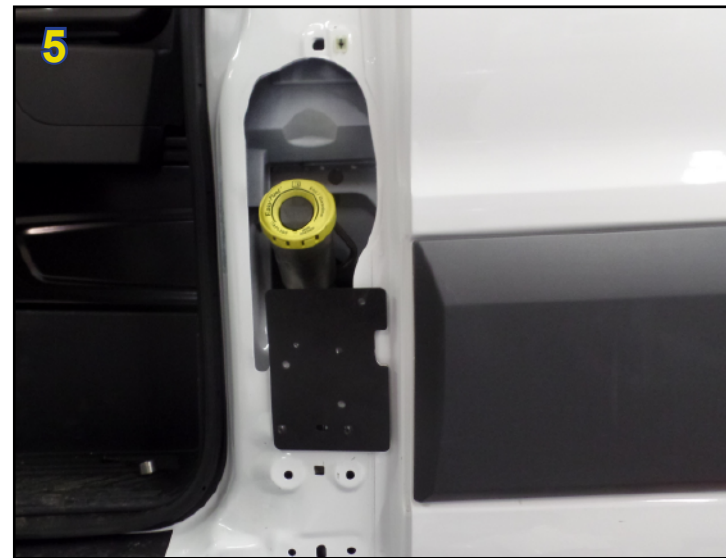

## FUEL FILL INSTALLATION

8. Assemble receptacle with straight fitting and 12 1/2" high pressure hose. Tighten to 30-35 ft-lbs.
9. Combine with CNG fill cup. Secure with CNG fill cup bracket. Slightly tighten.
10. Install assembly into place. Secure with three 1/4-20 x 1 bolt, 1/4-20 nylock nut (008), and 1/4 SAE flat washer (171). Install spacer where shown (bottom left). Tighten all to 5-7 ft-lbs.
11. Modify OEM fill housing by creating a 3 1/2" hole using the jig. Make an additional modification marked in white. Cut corner around 1/2".

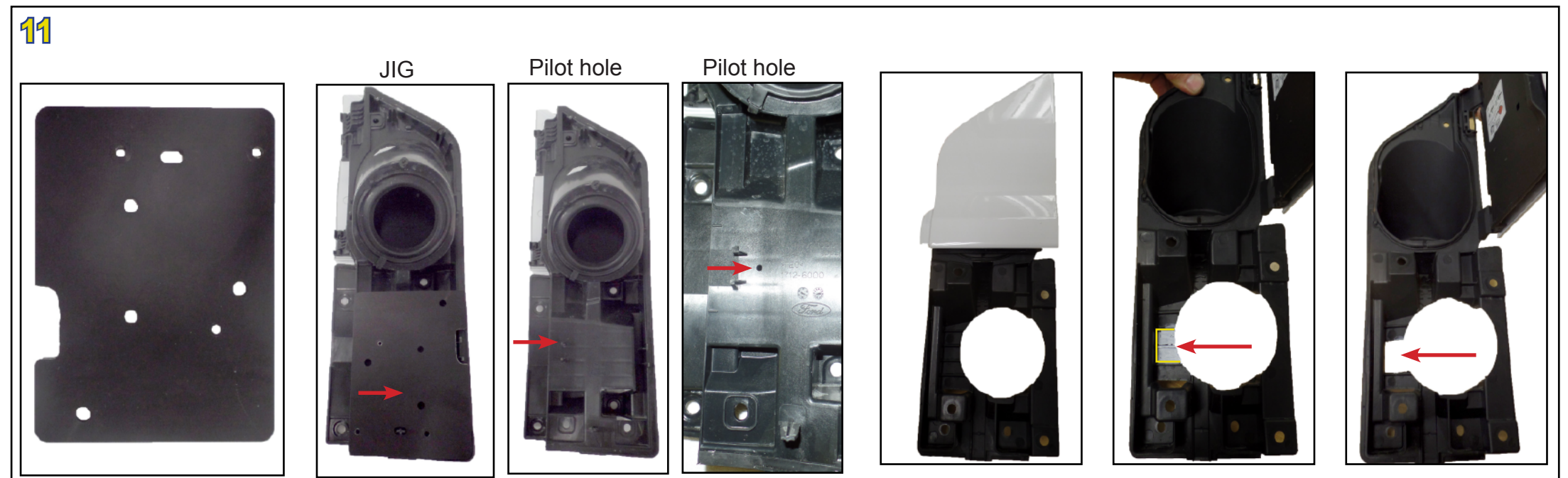
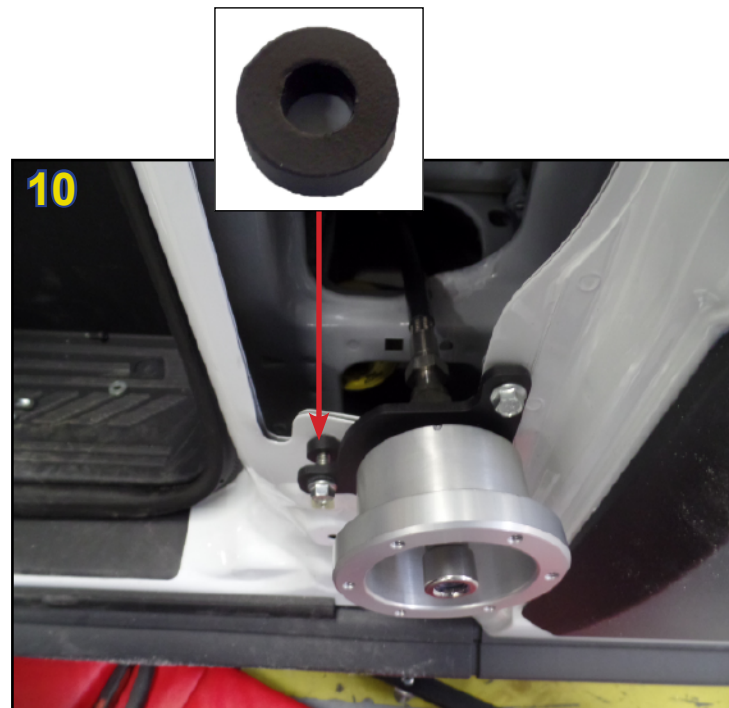
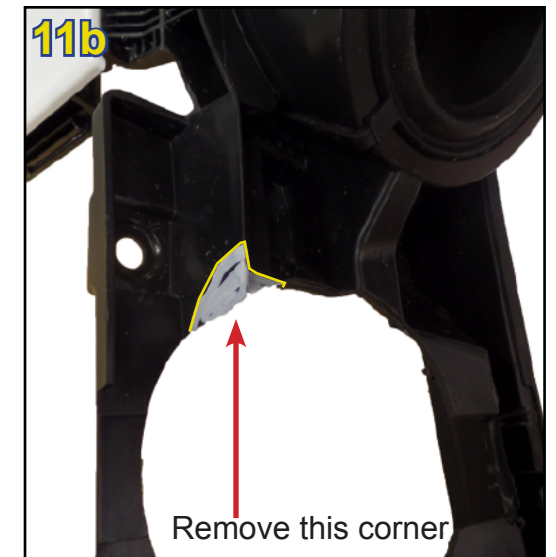

## FUEL FILL INSTALLATION

12. Install OEM fuel fill housing over the CNG receptacle. Secure with three OEM screws.
13. Modify the gray plastic trim.  
Use pilot hole cap and place over receptacle.  
Press gray plastic trim hard enough to imprint new pilot hole location.  
Drill pilot hole.  
Place pilot hole cap back onto receptacle and verify that the cap point is in exact center of the pilot hole.

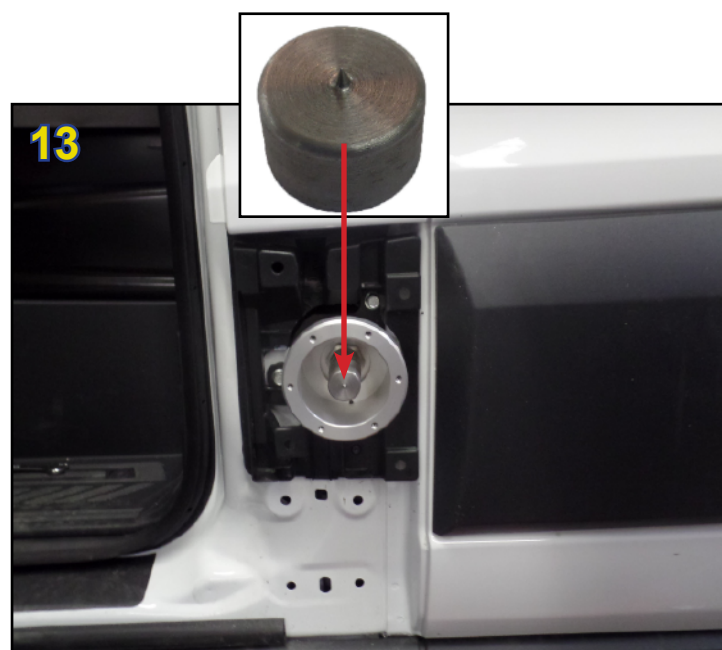

## FUEL FILL INSTALLATION

14. Modify the plastic trim by creating 2 9/16" hole. Deburr.
15. Install fuel fill ring. Refer to recommended alignment.  
Drill six 3/16" holes.  
Remove pilot hole cap.
16. Install plastic trim into place. Secure fuel fill ring to receptacle housing with six screws (182).
17. Tighten receptacle to 35 ft-lbs.
18. Apply decal and place rubber cap over receptacle.  
Re-install bottom cap panel.

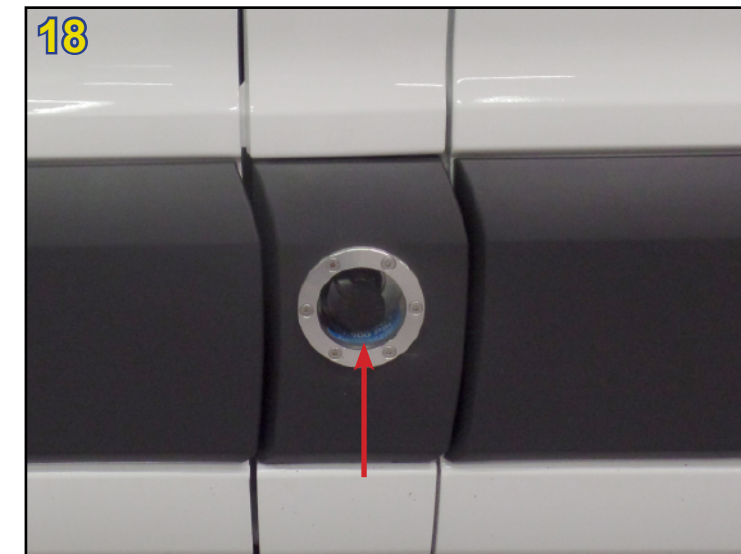
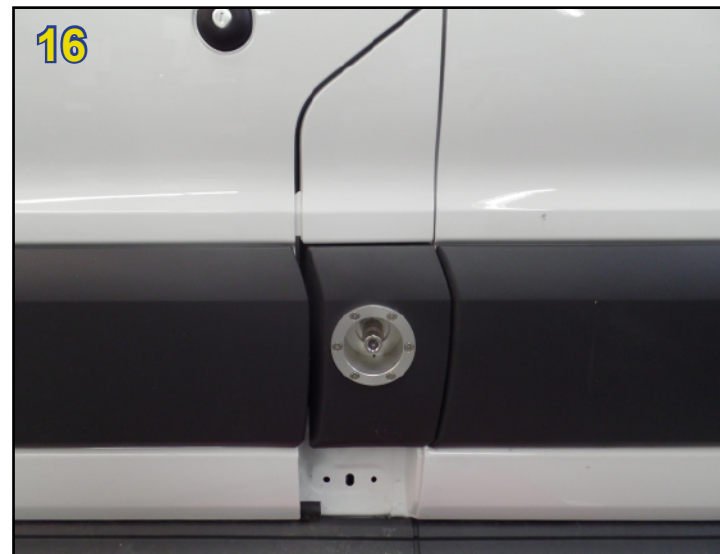
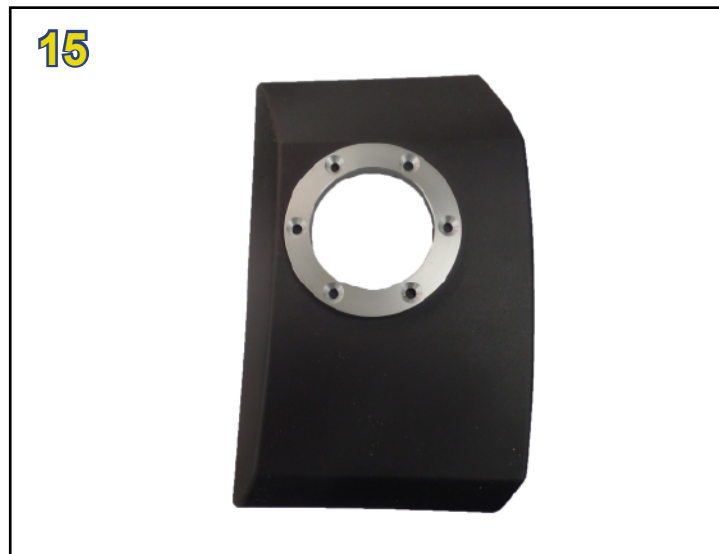
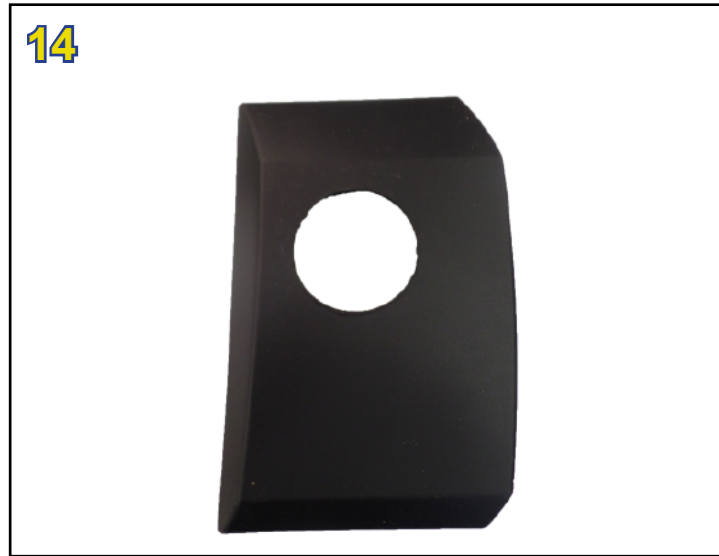

## REGULATOR / FILTER / QUARTER TURN SHUT-OFF ASSEMBLY INSTALLATION

1. Located under driver side door. Thread the OEM provided hole on frame to M8 - 1.25.
2. Install a 1/2" rivet nut in OEM provided hole in frame.
3. Install the pre-assembled regulator/filter/quarter turn assembly.
4. Secure with M8 - 1.25 x 25mm bolt and nylock, Tighten to 15-18 ft-lbs.
5. Secure the 3/8 - 16 bolt and nylock to tivet in frame. Torque to 25-30 ft-lbs
6. Secure the third 1/2" bolt with washer, nylock and nut to the frame bracket with existing OEM hole. Torque to 50-55 ft-lbs.

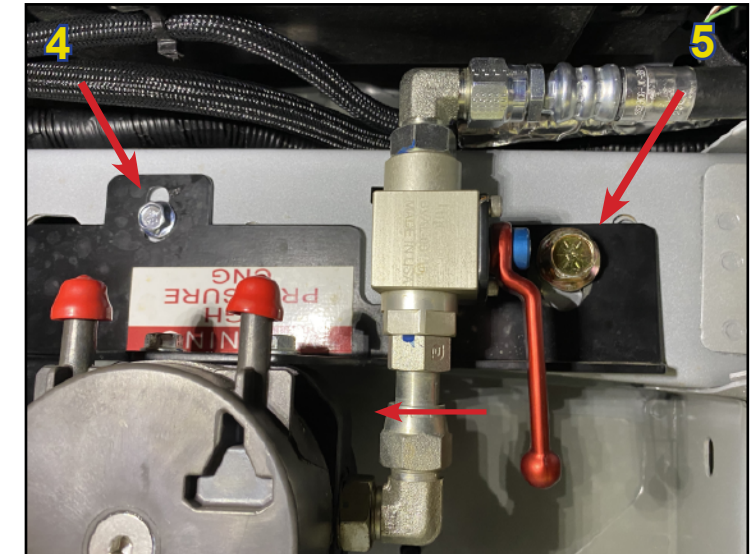
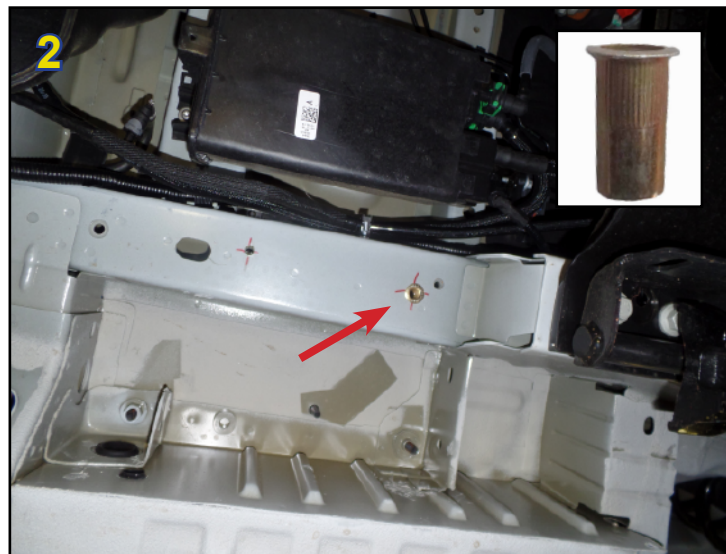

## ROUTING THE LOW PRESSURE NATURAL GAS FUEL HOSE

1. Connect the low pressure natural gas fuel hose to quarter turn valve. Torqued to 30-35 ft-lbs.
2. Route the low pressure hose along the inside of the frame and into the engine compartment.
3. Zip tie hose to OEM harness. No loose or hanging hose. Prevent hose from contact with areas that can cause abrasion, rubbing or wear on hose. (You may hold off this step until coolant hoses and rear harness has been installed and then zip tie all three together to the OEM harness).
4. Connect low pressure hose to the CNG fuel rail assembly. Torque to 30-35 ft-lbs.
5. Attach a Caution 150 PSI sticker on the on hose in engine compartment.
6. Attach a Caution 150 PSI sticker on the on hose in near quarter turn valve.

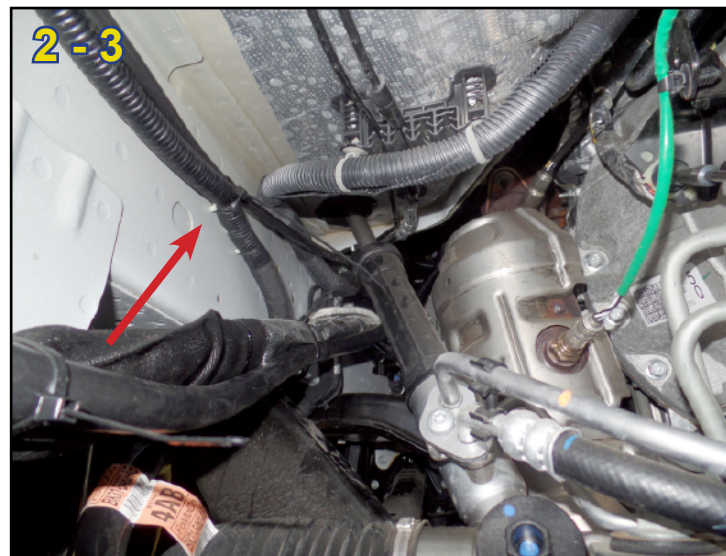
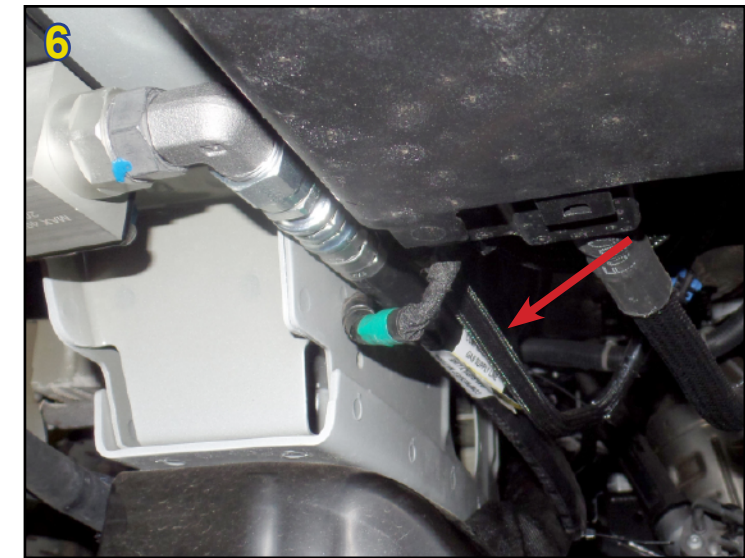

## INSTALLATION OF COOLANT HOSES - UNDER BODY

1. Route the two coolant hoses along the same path as the low pressure hose and rear harness along the inside of the frame.
2. Start routing from under vehicle and feed the coolant hoses into the engine compartment. Heat shielding on hose should be closest to engine.
3. Connect the coolant hoses to the regulator and secure with hose clamps. One hose should have colored tape on it to identify the "IN" location on the regulator.
4. Zip tie the coolant hoses to the low pressure hose and OEM wire harness. No loose or hanging hoses. Prevent hoses from contact with areas that can cause abrasion, rubbing or wear on hoses.

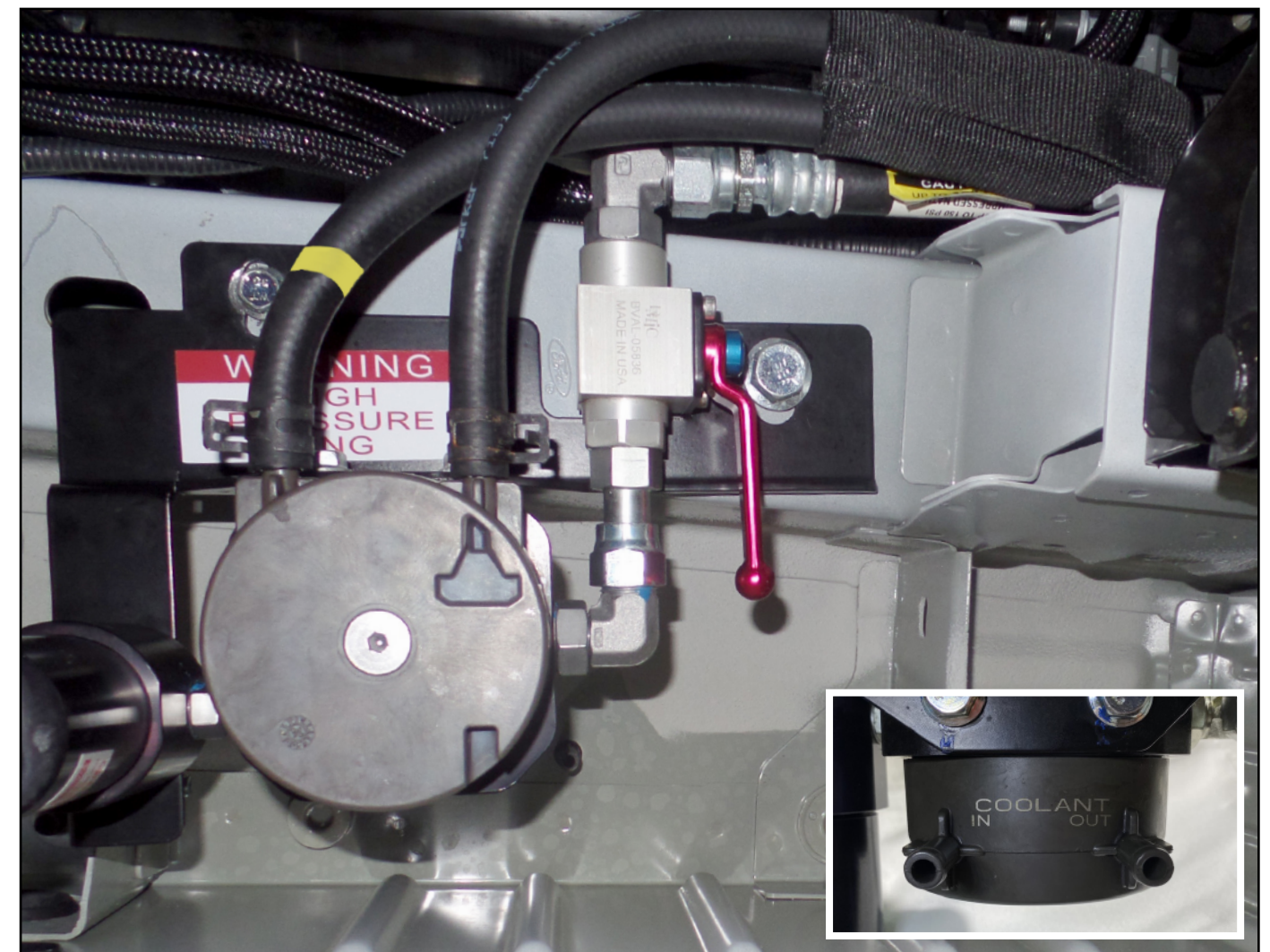
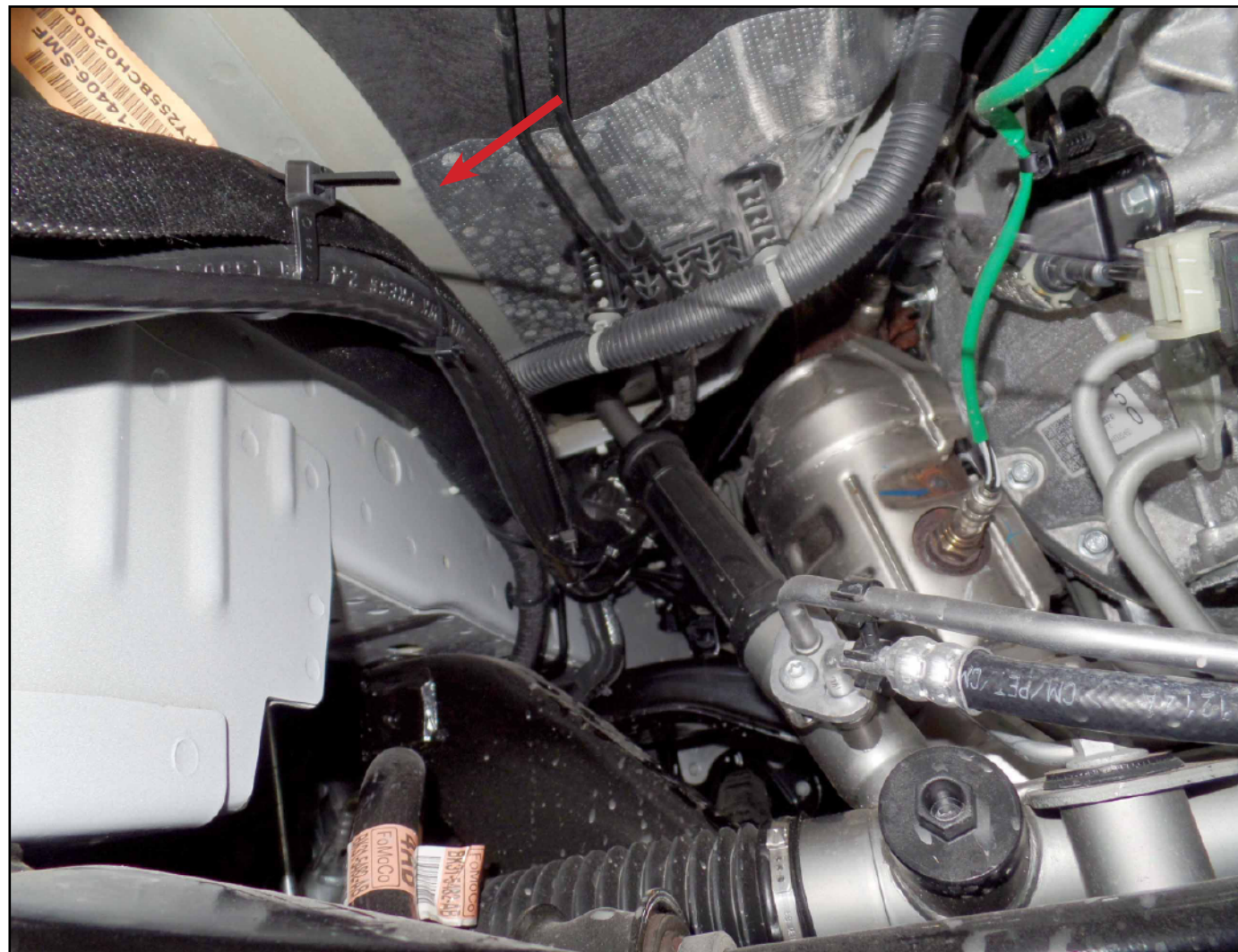

## INSTALLATION OF COOLANT HOSES - ENGINE COMPARTMENT

5. In the engine compartment find the coolant reservoir on driver side.
6. Disconnect the OEM coolant hose connected to the reservoir. Attach the straight plastic fitting to OEM coolant hose and secure with hose clamp.
7. Connect the coolant hose from kit with colored tape on it to the straight fitting and secure with hose clamp.
8. Connect the other coolant hose from the kit with no colored tape onto the reservoir and secure with hose clamp.
9. Make sure hose are not kinked or bending to much, push hoses down into engine compartment area as needed. Prevent hoses from contact with areas that can cause abrasion, rubbing or wear on hoses.

**NOTE:** Some liquid may spill out of OEM coolant hoses. Use caution when removing hoses. Use eye protection.

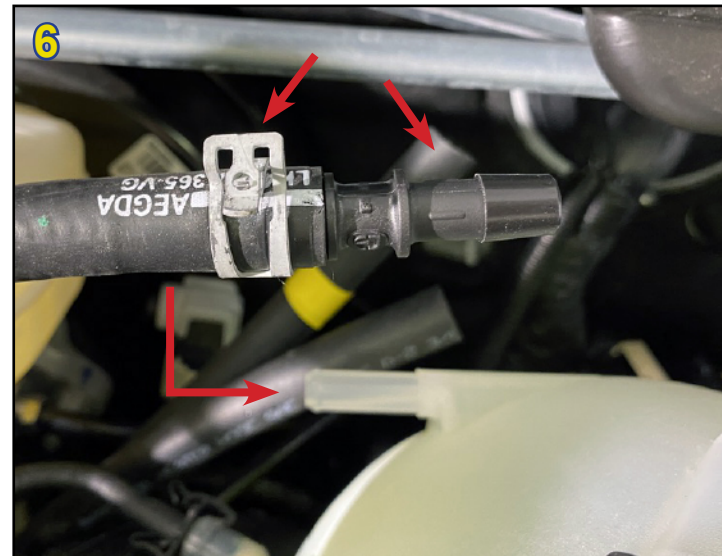



## CYLINDER COVER INSTALLATION (FRONT TO BACK - DRIVER SIDE)

1. Place cover decal inside the cylinder cover and on the box bracket closest to the valve.
2. Place eight u-nuts (333) on front and back cylinder plates.
3. Place cover over cylinder and secure with eight 1/4-20 x 1" bolts (334).

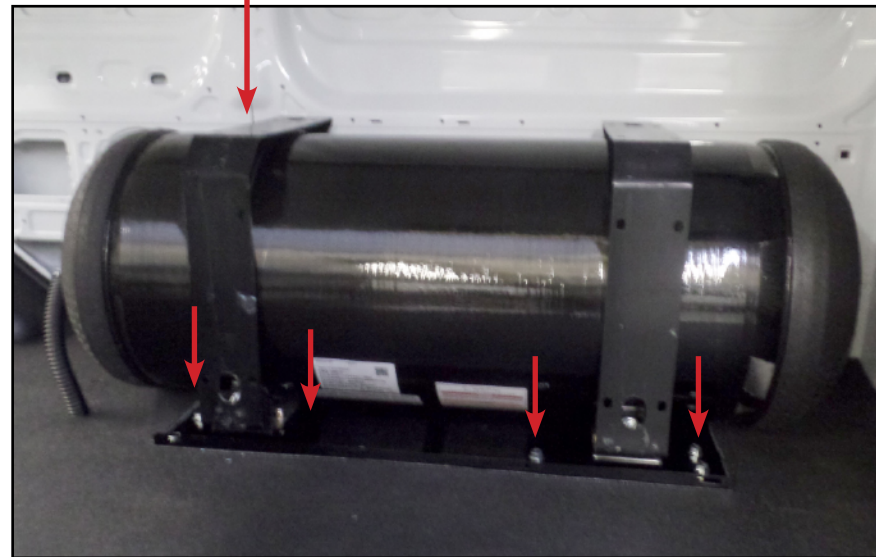

## CYLINDER COVER INSTALLATION (LEFT TO RIGHT - BEHIND FRONT SEATS)

1. Place cover decal inside the cylinder cover and one on cylinder strap closest to the valve.
2. Place four u-nuts (333) on front cylinder base plate and four onto rear cylinder base plate.
3. Place cover over cylinder and secure with eight 1/4-20 x 1" bolts (334).

**WARNING**  
CNG CYLINDER COVER MUST BE IN PLACE FOR NORMAL OPERATION.  
G-00609



**WARNING**  
CNG CYLINDER COVER MUST BE IN PLACE FOR NORMAL OPERATION.  
G-00609



# DECAL / STICKER PLACEMENT LOCATIONS

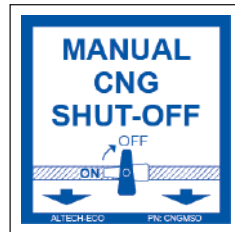
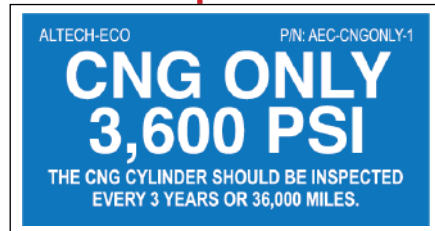
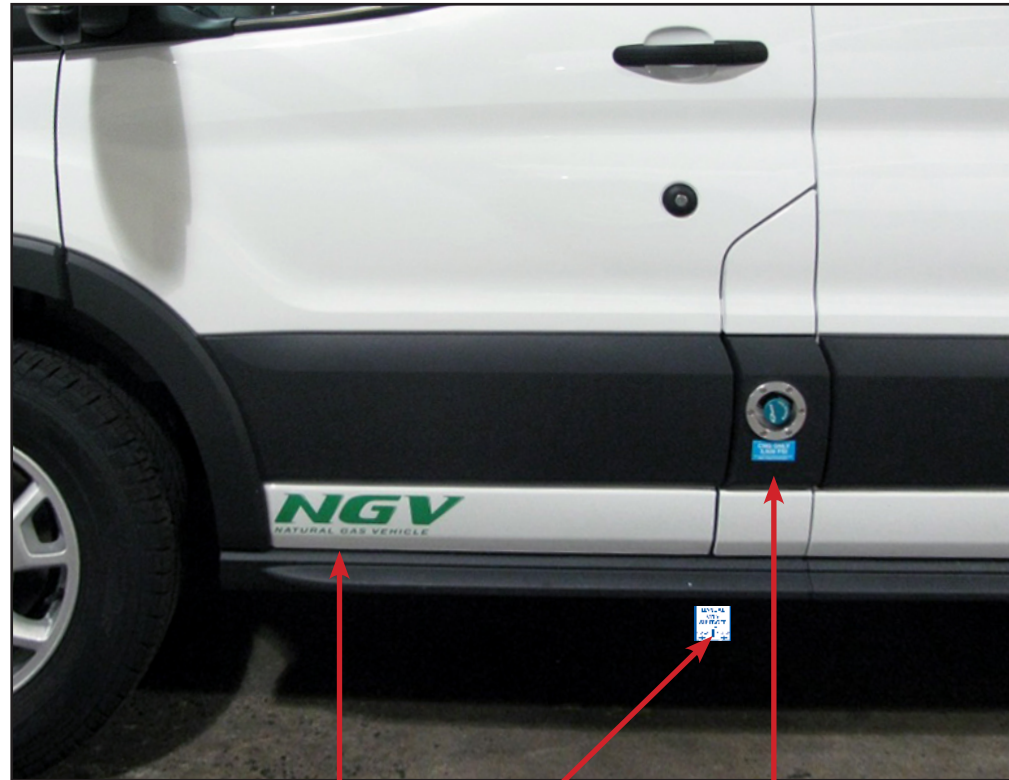

All high pressure hoses must be labeled with a high pressure sticker.

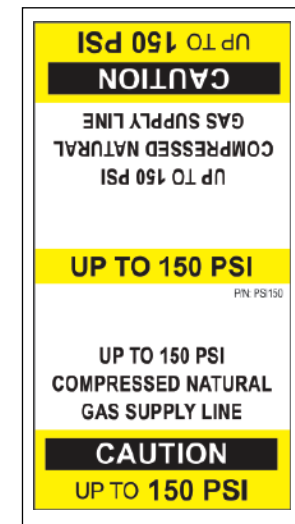

All low pressure hoses must be labeled with a low pressure sticker.

# DECAL / STICKER PLACEMENTS LOCATIONS

**WARNING**

**CNG CYLINDER / CONTAINER INFORMATION**

WATER VOLUME: \_\_\_\_\_ N GALLONS  
 EXPIRATION DATE: \_\_\_\_\_

THIS VEHICLE IS FUELED BY COMPRESSED NATURAL GAS WHICH IS STORED IN A CNG CYLINDER AT HIGH PRESSURE TO AVOID RISK OF INJURY DO NOT ATTEMPT TO SERVICE THE FUEL SYSTEM WITHOUT PROPER SYSTEM DEPRESSURIZATION ONLY QUALIFIED TECHNICIANS SHOULD SERVICE THIS VEHICLE. DO NOT USE CNG CYLINDER AFTER ITS EXPIRATION DATE.

THE CNG CYLINDER / CONTAINER SHOULD BE VISUALLY INSPECTED AFTER A MOTOR VEHICLE ACCIDENT OR FIRE AND AT LEAST EVERY 3 YEARS OR 36,000 MILES, WHICHEVER COMES FIRST, FOR DAMAGE AND DETERIORATION.

SERVICE PRESSURE: \_\_\_\_\_ PSI  
 IF THERE IS A LEAK OR A PROBLEM WITH PROPER USE, INSTALLATION OR MAINTENANCE OF THE CNG CYLINDER CONTACT THE CNG CYLINDER MANUFACTURER OR ALTECH-ECO AT (828) 654-8300.

**VEHICLE EMISSION CONTROL INFORMATION**

ALTECH-ECO CORPORATION  
 101 Fair Oaks Road • Asheville, North Carolina 28804 • Phone: (828) 654-8300

This vehicle is equipped with a coast-to-coast, full-ported conversion system designed to operate on compressed natural gas (CNG) or gasoline. This coast-to-coast full-ported system has been certified to meet EPA emission standards. This conversion was manufactured and installed in accordance with the principles of good engineering, proper and all J & SIA regulations and related state and local codes for the test group: FFA120303 and FFA120304.

CONFORMS TO EPA REGULATIONS: U.S. EPA T8112 OBD: FI  
 MODEL YEAR: 2019 FUEL: Vehicle Category: \_\_\_\_\_  
 TEST GROUP: JECTS15-0304 EVAP FAMILY: JECTS15-0304 JECTS15-0304L JECTS15-0304R

Install by: Altech-Eco Corp. Install Date: 03-01-23 Mileage: 125  
 Address: 101 Fair Oaks Rd. City: Asheville State: NC  
 Zip: 28734 Phone #: 828-654-8300 Pin: 28734

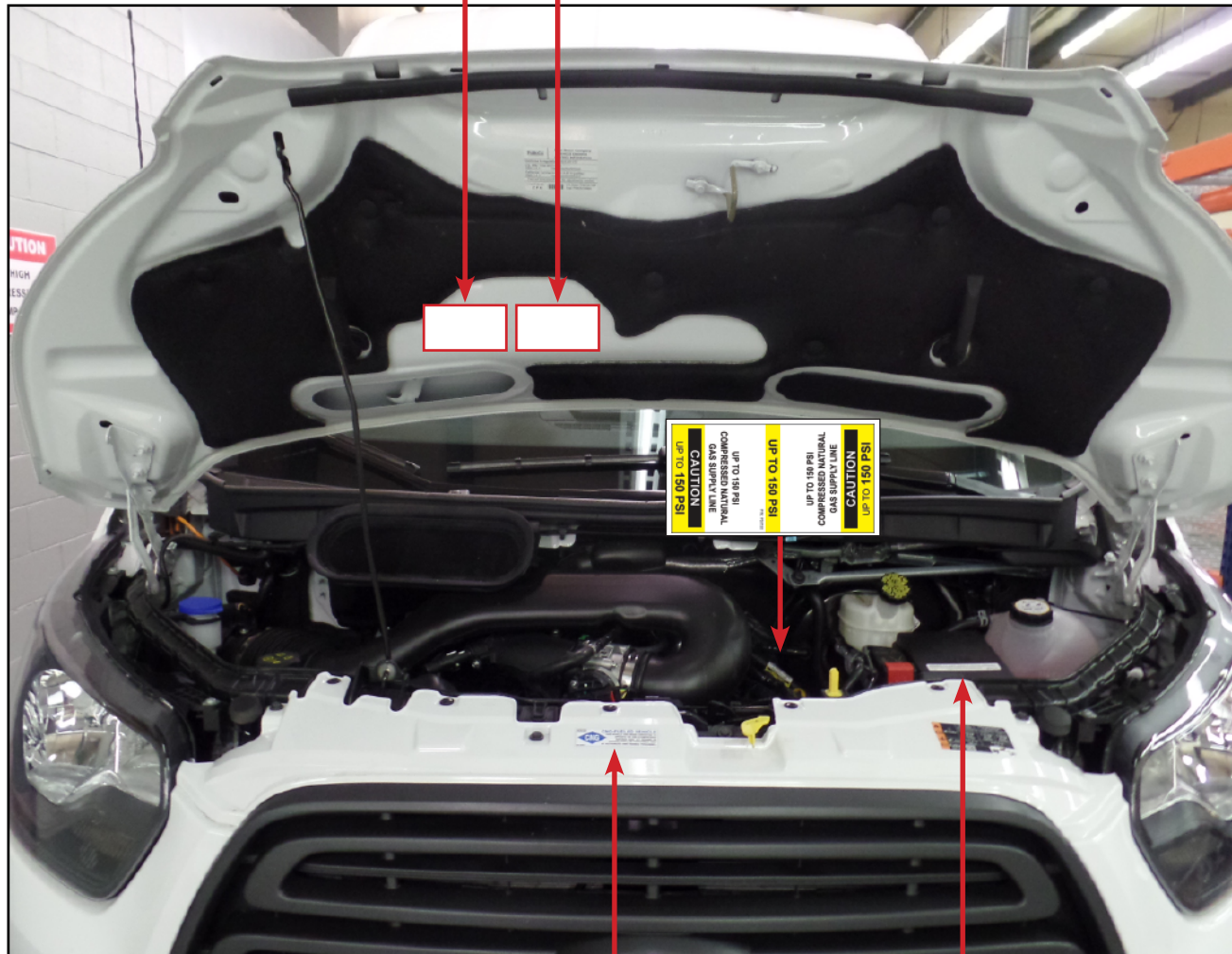

**CAUTION**

UP TO 150 PSI  
 CNG SUPPLY LINE  
 UP TO 150 PSI  
 CAUTION  
 UP TO 150 PSI  
 CNG SUPPLY LINE  
 UP TO 150 PSI

ALTECH-ECO CORPORATION  
 101 FAIR OAKS ROAD  
 ASHEVILLE, NC 28804

**CNG-FUELED VEHICLE**

THIS VEHICLE HAS BEEN CONVERTED TO OPERATE ON CNG (COMPRESSED NATURAL GAS). ALL REPAIRS OR SERVICE SHALL BE PERFORMED ONLY BY AUTHORIZED AND TRAINED PERSONNEL.

Pin: CMBBY

**WARNING:** The engine program is not to be re-flashed or updated without first contacting the engine gaseous modifier.

G-E9604-1 Program Questions Call: 828-654-8300

ALTECH-ECO CORPORATION



CNG mode is disabled when gasoline low fuel level indicator is illuminated.

Pin: MHGS

**WARNING:** The engine program is not to be re-flashed or updated without first contacting the engine gaseous modifier.

G-E9604-1 Program Questions Call: 828-654-8300

ALTECH-ECO CORPORATION

## LEAK & FINAL SYSTEM INSTALLATION QUALITY CONTROL INSPECTION

**A final inspection and leak test must be performed after the Altech-Eco natural gas system has been installed on the vehicle.**

- All natural gas fuel connections, hoses, fittings, valves, fuel rails, injectors, etc... must be checked for leaks.
- All wiring installed or modified must be checked for proper installation. There is to be no loose or hanging wires. All wiring must be zip tied (with ends snipped) to appropriate locations as to prevent abrasion and wear from vibration.
- All coolant hoses and connections must be checked for leaks. Be sure the coolant has been filled and topped off prior to starting the vehicle.

### **Tools needed for leak testing the natural gas:**

- Combustible Gas Leak Detector TPI 721 (ex. Davis Instruments)
- Certified Leak Detecting Solution "Bubble Soap"

### **Procedures:** (Fix any issues as needed)

1. Inspect all wiring that is secured properly with no hanging or loose wires. All zip tie ends should be snipped.
2. Inspect all (coolant / natural gas) hoses and fittings that they are secured and tightened per torque specifications.
3. Perform a natural gas leak test.
  - Close the tank valve by turning the "wheel" handle clockwise until snug.
  - Pressurize the system to 3600 psi. using an appropriate device.
  - Leak test the system by using a methane detector or certified leak detecting solution "bubble soap".
    - a. PASS (No Leaks): Continue to step 4.
    - b. FAIL (Leak Detected): Depressurize the system and correct the issue. Then repeat step 3.
4. Open the manual tank valve by turning the "wheel" handle counter clockwise until fully open, then turn it clockwise a 1/4 turn (this will help avoid the valve handle from sticking in the future).
5. Fill the tank with a natural gas fueling device to 3,600 psi.
6. Use the vehicle key and turn the ignition to the ON position, do not crank the vehicle. When ignition is turned to the ON position it opens the electronic solenoid tank valve and pressurizes all the hoses from the tank to the fuel rails.
7. Turn the ignition OFF, then back to ON and crank the engine. While the engine is running, perform a leak test by using a methane detector or certified leak detecting solution "bubble soap".
  - a. PASS (No Leaks): Complete required paper work.
  - b. FAIL (Leak Detected): Turn OFF the ignition and manually close the "wheel" handle on tank valve. Depressurize the system and correct any issues. After all corrections have been made, manually open the "wheel" handle on tank valve and crank the engine. Run the leak test again. For un-repairable issues, notify appropriate personnel for further instructions.
8. After completing the final checklist, it is required that an original or a copy of the entire completed checklist is to be sent to Altech-Eco.



To open the manual tank supply valve, turn "wheel" handle counter-clockwise until fully open. Then turn "wheel" handle clockwise 1/4 turn.

---

## Contact Information

### Technical Support:

Tel: 828-654-8300

Fax: 828-654-8747

Email: [customerservice@altecheco.com](mailto:customerservice@altecheco.com)

Address: 101 Fair Oaks Road, Arden NC 28704